



BUYMAGNETS.COM

A Bunting® Magnetics Company

**Largest Online Supplier Of Magnets,
Industrial Magnetic Equipment.**

Leading Supplier of Neodymium Magnets

In Stock for Immediate Shipment

 **BUNTING®**
Magnetics Co.

Lower Prices Bigger Selection

Check Out Our New Website TODAY!

BUYMAGNETS.COM

Items: 0 Total: \$0.00 1-800-232-4359

BUY MAGNETS ON-LINE SHOP TECHNICAL COMPANY

Largest Online Magnet Supplier
BUYMAGNETS.COM

QUICK SEARCH
Find what you need with just a couple of clicks.

BROWSE SHOP
Computer window shop through the largest on-line magnet store.

REQUEST CATALOG
If you would like to request a catalog please click go.

STAY ATTRACTED
For updates join Our BuyMagnets E Mail list.

55% OFF SELECT ALNICO PRODUCTS
FREIGHT Shipping on orders of \$250 or more!

NEW ITEM FEATURE ITEM SALE ITEM FEATURE ITEM

N42 PLATED DISC PRESS FEEDERS SAMARIUM COBALT BLOCKS

LOWEST Prices on Hopper and Cartridge Magnets*

Select Alnico Prices Slashed
↓ 55%

*compared to major competitors



BUYMAGNETS.COM

A Bunting® Magnetics Company

- Largest Online Selection of Magnets
- Neodymium Magnet Leader
- All In-Stock Items Ship Within 24 Hours
- Low Prices
- Magnet Specialists for Over 50 Years
- Supplying Magnets to More Industries than any other Magnet Supplier

All product information is liable to change, please contact Bunting to verify all product information including dimensions and capabilities.

Buy Bunting®

Permanent Magnets and Magnetic Products for Industry



Get Everything You Need From One Source

Bunting® Magnetics Co. offers you the largest selections of permanent magnets and industrial magnetic equipment in the world. Permanent Magnets and Holding Assemblies in hundreds of shapes and sizes are in our warehouse inventory, along with a wide assortment of magnetic tools for workholding, lifting, and plant maintenance. To discover the many ways Bunting® products can save you money, time, and labor, look over the off-the-shelf items listed in this catalog.

Check Out Our New Products

Our catalog is a work-in-progress. Changes occur in some products, new product offerings are added, and occasional deletion of obsolete products occur. Check out our new line of Countersunk Neodymium and Countersunk Neodymium Assemblies.

Don't See What You Need, Call Us!

This catalog will introduce you to the thousands of industrial magnets and magnetic products we carry in stock. But if you don't see what you need, be sure to call for more information. We supply many more products than we could feature in these pages, and we'll be glad to answer your questions. You can order all of them from our centrally located Chicago facility by calling 800-232-4359 toll free.

Get Magnets, Magnet Materials, and Magnetic Products – FAST

All in-stock items are ready for immediate shipment and fast delivery whenever and wherever you want them. You can expect shipment within 24 hours of your call on most of the standard magnets and products listed in this catalog. You'll also enjoy prompt service when you order custom-cut magnets. We'll ship your order directly from Chicago by land or air.

Bunting® Stock Magnets Meet MMPA Standards, ROHS, REACH

You can count on Bunting. Our stock magnets meet or exceed Magnetic Materials Producers Association Standards for physical quality and magnetic properties, and all permanent magnetic products are ROHS and REACH compliant.

Quick Reference

Permanent Magnetic Materials

Rare Earth	2-6
Alnico	7-15
Ceramic	16-17

Flexible Magnetic Strips & Sheets	18-21
---	-------

Permanent Magnetic Holding Assemblies

Alnico, Ceramic, & Rare Earth	22-28
-------------------------------------	-------

ValueMag™ Magnetic Holding Assemblies.....	29-31
--	-------

ValueMag™ Magnetic Separation Products	32
--	----

Magnetic Catches and Door Stops	33-36
---------------------------------------	-------

Permanent Magnetic Tools	37
--------------------------------	----

Electromagnets & Power Supplies.....	38-42
--------------------------------------	-------

Permanent Magnetic Lifters	43
----------------------------------	----

Magnetic Drive Rollers	44
------------------------------	----

Permanent Magnetic Sheet Fanners	45-46
--	-------

Permanent Magnetic Sweepers	47-48
-----------------------------------	-------

Torpedo In-Line Magnets	49
-------------------------------	----

Grinder Plate Magnets.....	49
----------------------------	----

Bread Pan Magnets	50
-------------------------	----

Frequently Asked Questions.....	51
---------------------------------	----

**Ask for FREE Samples.
Available on Most Products.**

**FOR TECHNICAL INFORMATION AND TO
ORDER CALL 800-232-4359**



Order Online at www.BUYMAGNETS.com

Permanent Magnetic Materials

Rare Earth, Alnico, and Ceramic

In Stock – Rare Earth, Alnico, Ceramic Magnets, and More

Bunting® Magnetics Co. offers you one of the largest selections of in-stock permanent magnets available. In addition, we're glad to share our knowledge in the field of applied magnets to help you specify non-standard magnets to meet special needs. We can cut magnets to your specifications from Rare Earth, Alnico, and Ceramic.

You'll find hundreds of shapes and sizes ready for immediate shipment when you call. In fact, you can expect shipment on most of the standard magnets listed in this catalog **within 24 hours**. For custom orders, virtually any configuration and quantity you need can be prepared and sent to you from our centrally located Chicago stocking facility.

Stock Permanent Magnet Specifications Comparison Table

Use this table to evaluate and compare the magnetic properties and other specifications of the materials from which our standard, in-stock magnets are manufactured.

GRADE	RARE EARTH															
	ALNICO					CERAMIC			NEODYMIUM					SAMARIUM COBALT		
	SINTERED		CAST			1	5	8	35SH	35	38	42	50	18	22	26
MAGNETIC CHARACTERISTICS																
MAX. ENERGY PRODUCT (Bd Hd) MAX. (MGOe)	1.5	5.25	5.5	5.5	6	1	3.4	3.5	35	35	38	42	50	18	22	26
RESIDUAL INDUCTION Br. GAUSS	7100	7250	12700	8300	9000	2200	3800	3850	11900	12150	12500	12800	14300	8900	9500	10400
COERCIVE FORCE Hc-OERSTEDS	550	1975	640	1650	1600	1825	2400	2950	11000	11050	11800	11500	11500	8600	9200	9500
INTRINSIC COERCIVE FORCE Hci-OERSTEDS	575	2125	645	1860	1620	3250	2420	3250	>17000	13500	12000	>12000	>11000	>20000	>20000	20000
SATURATION MAGNETIZING FORCE Hs-OERSTEDS	2000	6000	3000	6000	6000	10000	10000	10000	30000	30000	30000	30000	30000	40000	40000	55000
RECOIL PERMEABILITY	6.4	3.2	2.1	2.0	3	1.15	1.05	1.07	1.05	1.05	1.08	1.05	1.05	1.05	1.05	1.05
MAGNETIC ORIENTATION (ANISOTROPIC)	YES	YES	YES	YES	YES	YES	YES	YES	YES	YES	YES	YES	YES	YES	YES	YES
MATERIAL CHARACTERISTICS																
DENSITY - LB./IN. ³	.243	.254	.265	.262	.265	.175	.177	.177	.275	.268	.268	.268	.268	.304	.304	.297
CURIE TEMP.-F°	1544	1562	1544	1580	1580	842	842	842	648	625	635	600	600	1380	1380	1515
MAX. PRACTICAL OPERATING TEMPERATURE-F°	1000	1000	1000	1000	1000	480	480	480	300	180	180	180	180	575	575	575
REVERSIBLE TEMP. COEF OF BR %/F°	.011	.006	.011	.006	.006	.105	.105	.105	.052	.066	.066	.061	.061	.022	.022	.019
HARDNESS-ROCKWELL	Rc43	Rc44	Rc50	Rc56	Rc58	---	---	---	Rc58	Rc55	Rc55	Rc58	Rc58	Ro53	Ro53	Ro56
UNSPECIFIED TOLERANCES																
UNFINISHED SURFACES (+/-)																
0 - .125	.005	.005	.015	.031	.031	*	*	*	+	+	+	+	+	+	+	+
.125 - .625	.010	.010	.015	.031	.031	*	*	*	+	+	+	+	+	+	+	+
.625 - 1.00	.015	.015	.015	.031	.031	*	*	*	+	+	+	+	+	+	+	+
1.00 - 3.00	---	---	.015	.031	.031	*	*	*	+	+	+	+	+	+	+	+
3.00 - 5.00	---	---	.015	.047	.047	---	*	*	---	---	---	---	---	---	---	---
5.00 - 7.00	---	---	.015	.062	.062	---	*	*	---	---	---	---	---	---	---	---
7.00 - 9.00	---	---	.015	.078	.078	---	*	*	---	---	---	---	---	---	---	---
9.00 - 12.00	---	---	---	.094	.094	---	*	*	---	---	---	---	---	---	---	---
GROUND SURFACES (+/-)	.005	.005	.005	.005	.005	.005	.005	.005	.005	.005	.005	.005	.005	.005	.005	.005
CONCENTRICITY (TIR.)																
0 - .500	.005	.005	.048	.048	.048	.020	.020	.020	---	.010	.010	.010	.010	---	---	---
.500 - 1.00	.010	.010	.048	.048	.048	.030	.030	.030	---	.020	.020	.020	.020	---	---	---
1.00 - 1.50	.015	.015	.093	.093	.093	3%	3%	3%	---	---	.030	.030	.030	---	---	---
1.50 - 3.00	---	---	.093	.093	.093	3%	3%	3%	---	---	---	---	---	---	---	---
CUT SURFACES (+/-)																
0 - 3.00	.015	.015	.015	.015	.015	.015	.015	.015	.005	.005	.005	.005	.005	.015	.015	.015
3.00 - 6.00	---	---	.015	.015	.015	---	.015	.015	---	---	---	---	---	---	---	---
6.00 - 12.00	---	---	.015	---	---	---	.015	.015	---	---	---	---	---	---	---	---

* Unfinished surfaces tolerances for Ceramic magnets are +/- 0.015 or 2%, whichever is greater.

+ Unfinished surfaces tolerances for Neodymium magnets are +/- 0.005.

High-Energy Rare Earth Magnets

High-Energy Magnets for Increased Holding Power for Reduced Size and Weight



Neodymium Magnets are the most widely used Rare Earth magnets. Some typical applications include cell phones, alternators, pacemakers, biasing applications, flow meters, gyroscopes, and linear actuators.

We stock Neodymium blocks and plugs in a variety of sizes and grades for immediate shipment. Corrosion-resistant nickel plating from .0004 inch to .0008 inch thick and heat-resistant grades are available. Nickel plating helps protect against corrosion. For high-temperature applications, Neodymium Grade 35SH can safely be used at operating temperatures up to 300° Fahrenheit (149° Celsius) – depending on the magnetic circuit. Call for technical advice.

Samarium Cobalt Magnets produce energy rivaling that of Neodymium. Typical uses include many hi-tech applications, such as computers, electronics, switches, and automotive

“under-the-hood” applications, where elevated temperatures apply.

Samarium Cobalt magnets are extremely hard and brittle and should be protected from shock and mechanical forces in their application when handling. They resist corrosion and retain most of their energy up to 575° Fahrenheit, making them ideal replacements for Alnico when high temperature use or miniaturization is required.

Samarium Cobalt 18 and 22 were the first Samarium Cobalt grades manufactured and are derived from nearly pure Samarium and Cobalt. Samarium Cobalt 26 has an even higher temperature stability than the 18 and 22 grades and is especially suited for applications demanding high energy in high-temperature environments.

Note: Magnetic Tolerances ± 5%
Dimensional Tolerances ± .005”

Demagnetization Curves

Neodymium Magnets

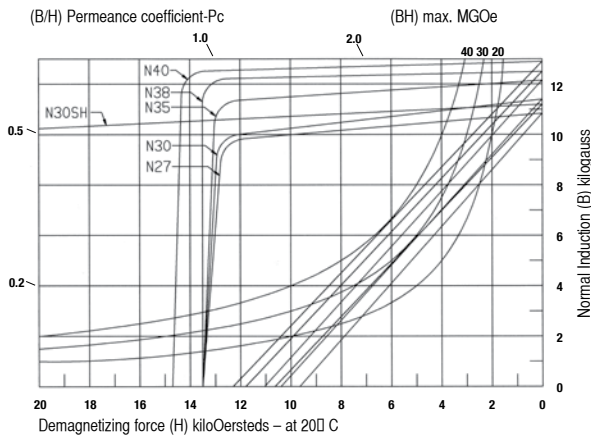

Samarium Cobalt Magnets

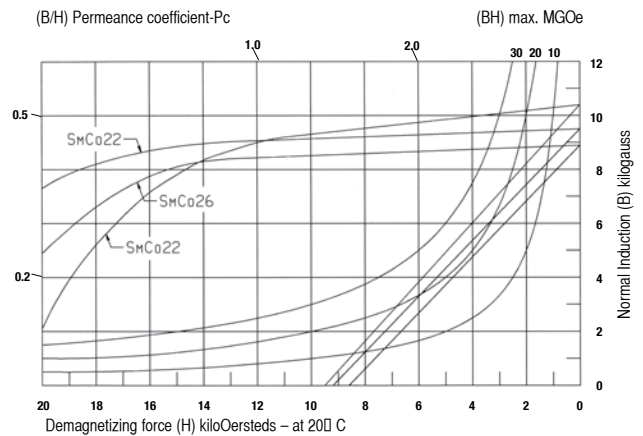

Permanent Magnetic Materials

Rare Earth

Block Samarium Cobalt 18 and 26 - Unplated

Part No.	T	W	L	Wt. (lbs)	Grade
SS-800AM	0.100	0.250	0.250	0.002	26
SS-801AM	0.100	0.250	0.250	0.003	18
SS-802AM	0.210	0.500	0.500	0.018	18
SS-803AM	0.210	0.500	0.500	0.019	26
SS-804AM	0.320	0.750	0.750	0.066	26
SS-805AM	0.320	0.750	0.750	0.058	18
SS-807AM	0.425	1.000	1.000	0.150	26

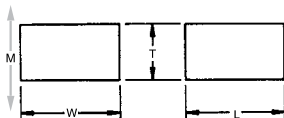

Disc Samarium Cobalt - Unplated

Part No.	D	T	Wt. (lbs)	Grade
SS-814AM	0.100	0.100	0.0005	18
SS-815AM	0.118	0.060	0.0002	18
SS-808AM	0.125	0.125	0.0008	18
SS-817AM	0.158	0.118	0.0008	18
SS-818AM	0.187	0.060	0.0005	18
SS-819AM	0.200	0.060	0.0007	18
SS-820AM	0.200	0.060	0.0005	26
SS-821AM	0.250	0.060	0.0010	26
SS-813AM	0.250	0.100	0.0016	26
SS-809AM	0.250	0.100	0.0016	18
SS-822AM	0.500	0.190	0.0090	22
SS-811AM	0.750	0.285	0.0440	26
SS-812AM	1.000	0.375	0.1300	26

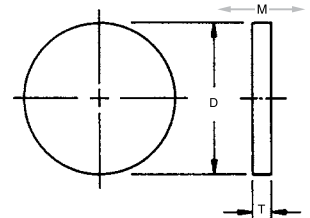

Permanent Magnetic Materials

Rare Earth - Sintered Neodymium

Block Neodymium 35 - Plated

Part No.	T	W	L	Wt. (lbs)	Holding Force (lbs)
NEB35P252510	.100	.250	.250	.002	1.4
NEB35P402010	.100	.200	.400	.002	1.8
NEB35P755025	.250	.500	.750	.024	15
NEB35P752534	.340	.250	.750	.018	7
NEB35P1004841	.410	.480	1.000	.069	15
NEB35P505050	.500	.500	.500	.033	10
NEB35P752550	.500	.250	.750	.024	7
NEB35P10010050	.500	1.000	1.000	.134	40
NEB35P20010050	.500	1.000	2.000	.269	80
NEB35P20020050	.500	2.000	2.000	.625	140
NEB35P200200100	1.00	2.000	2.000	1.067	180

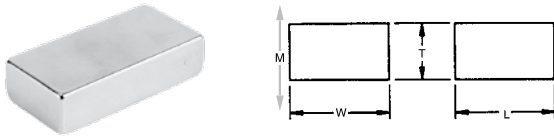

Block Neodymium 38 - Plated

Part No.	T	W	L	Wt. (lbs)	Holding Force (lbs)
NEB38P252512	.125	.250	.250	2.5	4
NEB38P502512	.125	.250	.500	5	6.5
NEB38P752512	.125	.250	.750	7.5	6
NEB38P755012	.125	.500	.750	10	7.4
NEB38P757512	.125	.750	.750	11	7.4
NEB38P1002512	.125	.250	1.000	7	11
NEB38P1005012	.125	.500	1.000	9	16.2
NEB38P15010012	.125	1.000	1.500	14	20
NEB38P252525	.250	.250	.250	7	11
NEB38P373725	.250	.375	.375	9	14
NEB38P502525	.250	.250	.500	11	28
NEB38P505025	.250	.500	.500	17.2	20
NEB38P752525	.250	.250	.750	20	28
NEB38P757525	.250	.750	.750	28	57
NEB38P1002525	.250	.250	1.000	20	57
NEB38P1005025	.250	.500	1.000	28	
NEB38P1007525	.250	.750	1.000	20	
NEB38P505037	.375	.500	.500	14	
NEB38P1005050	.500	.500	1.000	28	
NEB38P15010050	.500	1.000	1.500	57	

Disc Neodymium 35 High-Temperature (300°F) - Unplated

Part No.	D	T	Holding Force (lbs)
N35U125100HT	.125	.100	.7
N35U125125HT	.125	.125	.7
N35U250100HT	.250	.100	1.8
N35U250250HT	.250	.250	2.9
N35U320250HT	.320	.250	4.3
N35U375060HT	.375	.060	1.5
N35U375100HT	.375	.100	2.8
N35U375125HT	.375	.125	3.4
N35U375250HT	.375	.250	5.5
N35U875375HT	.875	.375	19



Disc Neodymium 35 High-Temperature (300°F) - Plated

Part No.	D	T	Holding Force (lbs)
N35P118060HT	.118	.060	.5
N35P125100HT	.125	.100	.7
N35P125125HT	.125	.125	.7
N35P157040HT	.157	.040	.7
N35P177098HT*	.177	.098	.8
N35P250100HT	.250	.100	1.8
N35P250125HT	.250	.125	2.1
N35P250250HT	.250	.250	2.9
N35P320250HT	.320	.250	4.3
N35P375060HT	.375	.060	1.5
N35P375100HT	.375	.100	2.8
N35P375125HT	.375	.125	3.4
N35P375250HT	.375	.250	5.5
N35P500250HT	.500	.250	8.2
N35P1000125HT	1.000	.125	11
N35P1000500HT	1.000	.500	32

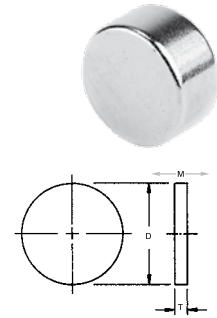

* Magnetized across diameter

Tech Tip

Bunting Magnetics Co. offers two temperature grades of neodymium. The standard grade has a maximum operating temperature of 180° F. The other grade (our HT designation) has a maximum operating temperature of 300° F.

- Direction of magnetization is through the thickness unless noted.
- Unless otherwise specified, magnets will be furnished in magnetized condition.
- Holding forces are approximate. These are average values obtained under laboratory conditions. Size, shape, and material of the test piece may affect actual pull forces.

Permanent Magnetic Materials

Rare Earth - Sintered Neodymium



Disc Neodymium Plated

Part No.	D	T	Holding Force (lbs)
Grade 35			
N35P062500	.062	.500	.2
N35P105138	.105	.138	.3
N35P120060	.120	.060	.5
N35P125125	.125	.125	.6
N35P125250	.125	.250	.8
N35P130500	.130	.500	1.1
N35P150350	.150	.350	.9
N35P187060	.187	.060	.8
N35P187125	.187	.125	.9
N35P187187	.187	.187	1.1
N35P187250	.187	.250	1.2
N35P187500	.187	.500	1.7
N35P220100	.220	.100	1.5
N35P220250	.220	.250	2.3
N35P220500	.220	.500	2.7
N35P250100	.250	.100	1.8
N35P250125	.250	.125	2.1
N35P250187	.250	.187	2.5
N35P250200	.250	.200	2.6
N35P250250	.250	.250	2.9
N35P250500	.250	.500	3.4
N35P315060	.315	.060	1.1
N35P320250	.320	.250	4.3
N35P375060	.375	.060	1.5
N35P375100	.375	.100	2.8
N35P375125	.375	.125	3.4
N35P375187	.375	.187	4.6
N35P375200	.375	.200	4.9
N35P375250	.375	.250	5.5
N35P375375	.375	.375	6.5
N35P375500	.375	.500	7
N35P500060	.500	.060	1.8
N35P500125	.500	.125	4.6
N35P500187	.500	.187	6.7
N35P500200	.500	.200	7
N35P500250	.500	.250	8.2
N35P500375	.500	.375	10.3
N35P500500	.500	.500	11.5
N35P625100	.625	.100	5
N35P625250	.625	.250	11
N35P750250	.750	.250	13.6
N35P750375	.750	.375	18.5
N35P750500	.750	.500	21.9
N35P750750	.750	.750	26.5
N35P830250	.830	.250	14.6
N35P830500	.830	.500	24.8
N35P870500	.870	.500	29.4
N35P8751000	.875	1.000	40.4
N35P1000187	1.000	.187	13.1
N35P1000250	1.000	.250	18.3
N35P1000375	1.000	.375	28.6
N35P1000500	1.000	.500	32.9
N35P1000750	1.000	.750	40.4
N35P1500375	1.500	.375	41
N35P2000500	2.000	.500	73

Disc Neodymium Plated

Part No.	D	T	Holding Force (lbs)
Grade 42			
N42P120060	0.120	0.060	0.5
N42P125125	0.125	0.125	0.7
N42P125250	0.125	0.250	0.9
N42P125375	0.125	0.375	2.1
N42P125500	0.125	0.500	1.2
N42P125750	0.125	0.750	1.2
N42P1251000	0.125	1.000	1.2
N42P187060	0.187	0.060	0.9
N42P187125	0.187	0.125	1.3
N42P187187	0.187	0.187	1.8
N42P187250	0.187	0.250	1.9
N42P187500	0.187	0.500	2
N42P187750	0.187	0.750	2.2
N42P220100	0.220	0.100	1.7
N42P220250	0.220	0.250	2.6
N42P220500	0.220	0.500	3
N42P250100	0.250	0.100	2
N42P250125	0.250	0.125	2.3
N42P250187	0.250	0.187	2.9
N42P250200	0.250	0.200	3
N42P250250	0.250	0.250	3.2
N42P250500	0.250	0.500	3.8
N42P250750	0.250	0.750	4.1
N42P2501000	0.250	1.000	4.2
N42P320250	0.320	0.250	4.9
N42P375060	0.375	0.060	1.7
N42P375100	0.375	0.100	3.1
N42P375125	0.375	0.125	3.8
N42P375187	0.375	0.187	5.8
N42P375200	0.375	0.200	6
N42P375250	0.375	0.250	6.1
N42P375375	0.375	0.375	6.7
N42P375500	0.375	0.500	7.9
N42P3751000	0.375	1.000	9.2
N42P3751500	0.375	1.500	9.5
N42P500125	0.500	0.125	5.1
N42P500187	0.500	0.187	9.1

Part No.	D	T	Holding Force (lbs)
N42P500500	0.500	0.500	12
N42P500750	0.500	0.750	14.9
N42P5001000	0.500	1.000	15.8
N42P5001500	0.500	1.500	16.5
N42P500060	0.500	0.060	2.1
N42P500200	0.500	0.200	7.9
N42P500250	0.500	0.250	9.3
N42P500375	0.500	0.375	11.6
N42P750125	0.750	0.125	7.1
N42P750250	0.750	0.250	14
N42P750375	0.750	0.375	19.5
N42P750500	0.750	0.500	23
N42P750625	0.750	0.625	25.5
N42P750750	0.750	0.750	28
N42P7501000	0.750	1.000	32.7
N42P7501500	0.750	1.500	35.5
N42P830250	0.830	0.250	21.4
N42P830500	0.830	0.500	33.3
N42P870500	0.870	0.500	36.1
N42P8751000	0.875	1.000	47.2
N42P1000125	1.000	0.125	8.5
N42P1000187	1.000	0.187	22.3
N42P1000250	1.000	0.250	20
N42P1000375	1.000	0.375	30
N42P1000500	1.000	0.500	35
N42P1000750	1.000	0.750	45
N42P1000875	1.000	0.875	50
N42P10001000	1.000	1.000	53
N42P10001500	1.000	1.500	59
N42P1500250	1.500	0.250	28
N42P1500375	1.500	0.375	58
N42P1500500	1.500	0.500	61
N42P1500750	1.500	0.750	84
N42P15001000	1.500	1.000	100
N42P15001500	1.500	1.500	145
N42P15002000	1.500	2.000	130
N42P2000500	2.000	0.500	105

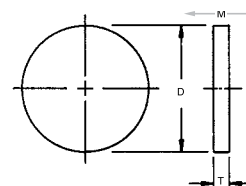

- Direction of magnetization is through the thickness unless noted.
- Unless otherwise specified, magnets will be furnished in magnetized condition.
- Holding forces are approximate. These are average values obtained under laboratory conditions. Size, shape, and material of the test piece may affect actual pull forces.

Permanent Magnetic Materials

Rare Earth - Sintered Neodymium

Disc Neodymium Plated

Part No.	D	T	Holding Force (lbs)
Grade 50			
N50P120060	.120	.060	.6
N50P140350	.140	.350	.9
N50P150035	.150	.035	.2
N50P187060	.187	.060	1.1
N50P220100	.220	.100	2.1
N50P220250	.220	.250	3
N50P250100	.250	.100	2.4
N50P250250	.250	.250	4
N50P250500	.250	.500	4.6
N50P375100	.375	.100	3.8
N50P375125	.375	.125	4.4
N50P500060	.500	.060	2.3
N50P500250	.500	.250	11.4

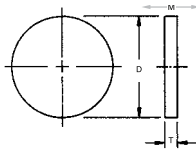

Rings Neodymium - Grade 35 - Plated

Part #	OD	ID	T	Pull (lbs)
N35P251225RG	.250	.125	.250	2.1
N35P371212RG	.375	.125	.125	3.3
N35P501212RG	.500	.125	.125	5.1
N35P502525RG	.500	.250	.250	7.2
N35P752525RG	.750	.250	.250	14.6
N35P1005050RG	1.000	.500	.500	29.8



Countersunk Disc Neodymium Plated

Part No.	OD	ID	T	Screw Size	Holding Force (lbs)
Grade 42					
N42P375125CS-N	0.375	0.136	0.125	#4	3.5
N42P375125CS-S	0.375	0.136	0.125	#4	3.5
N42P500125CS-N	0.500	0.136	0.125	#4	5.4
N42P500125CS-S	0.500	0.136	0.125	#4	5.4
N42P625125CS-N	0.625	0.170	0.125	#6	7.1
N42P625125CS-S	0.625	0.170	0.125	#6	7.1
N42P750125CS-N	0.750	0.194	0.125	#8	8.6
N42P750125CS-S	0.750	0.194	0.125	#8	8.6
N42P875125CS-N	0.875	0.194	0.125	#8	10.2
N42P875125CS-S	0.875	0.194	0.125	#8	10.2
N42P1000187CS-N	1.000	0.221	0.187	#10	20.5
N42P1000187CS-S	1.000	0.221	0.187	#10	20.5

N & S designation refers to the countersunk side
Tols. +/- .005"

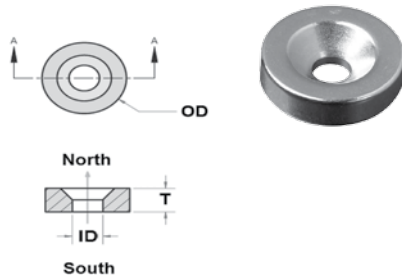

Disc Neodymium with Pressure Sensitive Adhesive (PSA) Grade 35 - Plated

Part #	D	T	Holding Force (lbs)
N35P250060PSAN	.250	.060	1.3
N35P250060PSAS	.250	.060	1.3
N35P375060PSAN	.375	.060	1.5
N35P375060PSAS	.375	.060	1.5
N35P500060PSAN	.500	.060	1.8
N35P500060PSAS	.500	.060	1.8

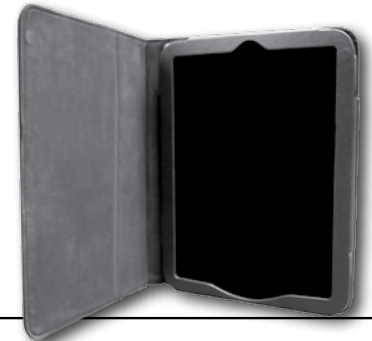

Tech Tip
Velcro is history, magnets are the future. Yes, magnets. The world is becoming quieter thanks to the unrivaled power of magnets. Magnets are being used for binders, boxes, folders and other packaging and presentation materials. **Out with the loud rip of velcro - and in with the quiet, powerful snap of magnets!**

- Direction of magnetization is through the thickness unless noted.
- Unless otherwise specified, magnets will be furnished in magnetized condition.
- Holding forces are approximate. These are average values obtained under laboratory conditions. Size, shape, and material of the test piece may affect actual pull forces.

Permanent Magnetic Materials

Rare Earth - Bonded Neodymium



Discs Bonded Neodymium

Part #	D	T	Holding Force (lbs)
NB001-AM	.118	.276	0.6
NB001-CM	.118	.138	0.3
NB001-EM Thru diameter	.118	.138	***
NB002-AM	.157	.276	0.8
NB002-BM	.157	.394	1.1
NB003-AM	.078	.394	0.6
NB003-CM	.078	.194	0.3
NB005-AM	.197	.394	1.4
NB005-CM	.197	.276	1.0
NB005-DM	.197	.157	0.6
NB005-EM	.197	.078	0.3
NB008-AM	.236	.078	0.3
NB008-BM	.236	.157	0.7
NB008-CM	.236	.394	1.7
NB012-AM	.394	.236	1.4
NB012-BM	.394	.394	2.9
NB013-AM	.492	.236	1.8
NB013-BM	.492	.394	3.6
NB015-AM	.591	.118	1.3
NB015-BM	.591	.394	2.1
NB015-CM	.591	.303	3.3
NB015-DM	.591	.394	4.3
NB017-AM	.787	.394	2.9
NB017-BM	.787	.303	4.4
NB017-CM	.787	.394	5.7
NB019-AM	.984	.394	3.6
NB019-BM	.984	.394	7.2
NB044-BM	.335	.118	0.7



Blocks Bonded Neodymium

Part #	L	W	T	Holding Force (lbs)
NB022-AM	.197	.197	.078	0.4
NB022-BM	.394	.197	.197	1.1
NB042-AM	1.967	.394	.472	8.7
NB042-BM	1.967	.394	.394	7.2
NB042-CM	1.967	.394	.197	3.6
NB042-DM	1.967	.394	.078	1.5
NB043-AM	1.181	1.181	.197	4.8
NB043-BM	1.181	1.181	.394	9.7
NB043-IM	1.181	1.181	.078	2.0
NB053-AM	.807	.303	.150	1.5
NB053-BM	.807	.303	.268	2.8
NB081-CM	1.967	1.967	.500	20.5
NB081-EM	1.967	1.967	.748	30.7
NB081-GM Un-magnetized	1.967	1.967	1.000	40.0
NB081-KM	1.967	1.967	.25	10.2

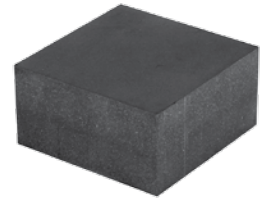

Rings Bonded Neodymium

Part #	OD	ID	T	Holding Force (lbs)
NB020-BM	1.024	.866	.197	0.6
NB020-CM	1.024	.866	.394	1.1
NB025-AM	1.378	.827	.394	4.0
NB025-CM	1.378	.811	.197	2.0
NB048-BM	1.181	.630	.394	4.0
NB048-CM	1.181	.630	.197	2.0



Bonded Neodymium Specs. Grade N10

Br 6800 gauss
Hc 5800 oersteds
Hci 9100 oersteds
BHmax 10 MGOe
Max Temp 302° F
+/- .127mm dimensional tolerances

Note: Bonded neodymium shapes shown on this page are machinable.

- Direction of magnetization is through the thickness unless noted.
- Unless otherwise specified, magnets will be furnished in magnetized condition.
- Holding forces are approximate. These are average values obtained under laboratory conditions. Size, shape, and material of the test piece may affect actual pull forces.

Cast Alnico 5 & 8 • Sintered 2 & 8 Magnets

The Right Choice for Superior Temperature Stability for Complex Shapes

Alnico Magnets derive their magnetic properties and their name from their main elements – aluminum, nickel, and cobalt. They have the widest range of temperature stability of any standard magnetic material. Other characteristics include high induction as well as relatively high energy.

We stock Alnico magnets in grades 2, 5, and 8. Alnico magnets are your best choice for applications exposed to operating temperatures above 400° Fahrenheit. Up to 1000°F, they maintain about 85 percent of their room-temperature magnetic properties, and changes in magnetization are reversible. See the Stock Magnet Specifications table on page 1 for detailed information.

Sintered Alnico has marginally lower magnetic properties, but better mechanical properties, than cast Alnico. Both are hard and brittle materials. They require skillful machining that is best performed on specialized equipment. The MMPA Standards for Alnico magnets state, in part: "These are materials used primarily for their magnetic capabilities...without regard to their mechanical properties. Therefore, it is generally not recommended that these materials be used for structural or decorative purposes." Alnico magnets can be pressed directly into nonmagnetic materials. For steel pressings, they should be enclosed in a nonferrous bushing. When specifications call for extremely tight tolerances or complex, non-standard shapes that will require considerable machining, magnetic materials that are easier to work with than Alnico should be considered.

Cast Alnico 5 has a maximum energy product of 5.5 and

it is a popular choice for applications such as holding assemblies, electronic instrumentation, sensing devices, and communications equipment. For best results with Alnico 5 magnets, the length should be no less than 5 times the cross-section diameter.

Cast Alnico 8 HE has the highest temperature stability of any commercially available magnetic material. So it is especially well-suited to high-temperature applications. Improved crystal structure and alloying techniques achieve a 6.0 energy product and high resistance to demagnetization. Typical uses include computer keyboards, drives, printers, microphones, meters, motors, generators, relays, reed-switch relays, transducers, and Hall-Effect devices.

Sintered Alnico 8H has a 5.25 energy product and high temperature stability, coercivity, and demagnetization resistance similar to Cast Alnico 8. But it can be manufactured to closer tolerances. Its fine grain structure results in highly uniform flux distribution and mechanical strength. So it is ideally suited to applications requiring short magnetic length or involving high-speed motion. Some applications include core meters, traveling wave tube stacks, polarized relays, reed switches, torque transmitting devices, and sandwich-type holding assemblies.

Sintered Alnico 2 has an energy product of 1.5. Magnets of this material are unoriented and can be magnetized in any direction.

Note: Alnico magnets are manufactured to MMPA Standard No. 0100-00.

Demagnetization Curves for Cast & Sintered Alnico Magnets

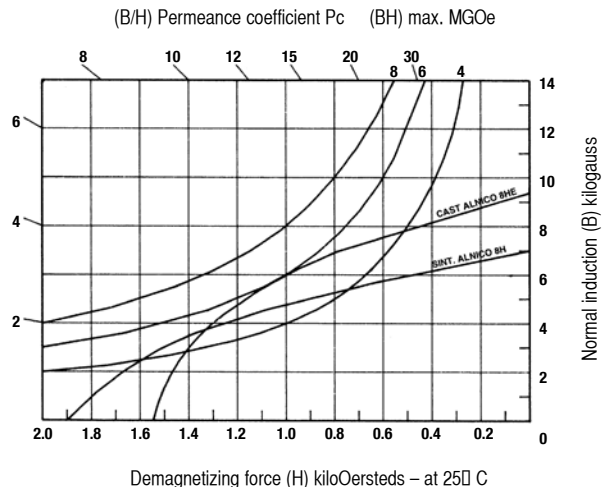
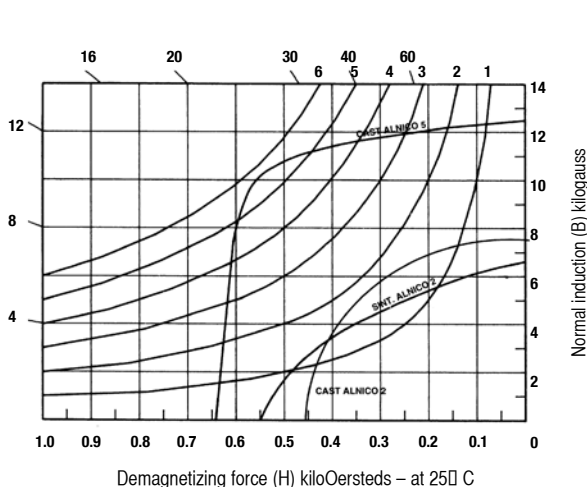

Permanent Magnetic Materials

Alnico



Square Bar Cast Alnico 5

Part No.	A	L	Wt. (lbs)
BS220-6	.250	6	0.10
BS230-6	.375	6	0.22
BS240-6	.500	6	0.39
BS250-6	.625	6	0.61
BS280-6	1.000	6	1.56

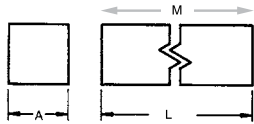

Rectangular Bar Cast Alnico 5

Part No.	A	B	L	Wt. (lbs)
BR312-4	.125	.250	4	0.03
BR323-6	.250	.375	6	0.15
BR324-6	.250	.500	6	0.19
BR326-6	.250	.750	6	0.29
BR328-6	.250	1.000	6	0.38

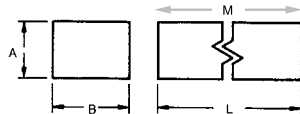

Tech Tip

To prevent demagnetizing in Alnico 5 Rods, the length / diameter ratio should be greater than 5.

Round Bar Cast Alnico 5

Part No.	D	L	Wt. (lbs)
R110-4	.125	4	0.01
R115-5	.188	5	0.04
R120-6	.250	6	0.08
R130-6	.375	6	0.17
R140-6	.500	6	0.31
R150-6	.625	6	.048
R160-6	.750	6	.702
R840-8	.840	8	1.25

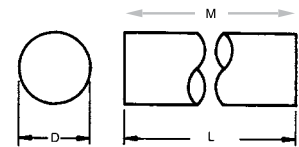

Centerless Ground Bar Cast Alnico 5

Part No.	D	L	Wt. (lbs)
CG403-4	.093	4	0.01
CG404-5	.125	5	0.02
CG406-6	.187	6	0.04
CG408-6	.250	6	0.08
CG410-6	.312	6	0.12
CG412-6	.375	6	0.18
CG414-6	.437	6	0.24
CG416-6	.500	6	0.31
CG420-6	.625	6	0.51
CG424-6	.750	6	0.70

Ground diameter (+.002 - .000)

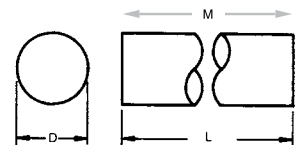

* All measurements are in inches.

** DOM - Direction of magnetization - indicated by gray arrows.

- Unless otherwise specified, magnets will be furnished in magnetized condition.
- Holding forces are approximate. These are average values obtained under laboratory conditions. Size, shape, and material of the test piece may affect actual pull forces.

Permanent Magnetic Materials

Alnico

U-Shaped Cast Alnico 5

Part No.	A	B	C	D	E	Wt. (lbs)	Holding Force (lbs)
CU605	.562	.797	.375	.344	.234	0.06	3.5

Pole faces ground

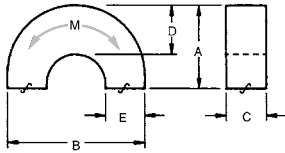

U-Shaped Cast Alnico 5

Part No.	Wt. (lbs)	Holding Force (lbs)
CU611	0.06	6

Pole faces ground

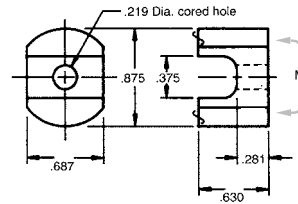

U-Shaped Cast Alnico 5

Part No.	Wt. (lbs)	Holding Force (lbs)
CU609	0.06	6.5

Pole faces ground

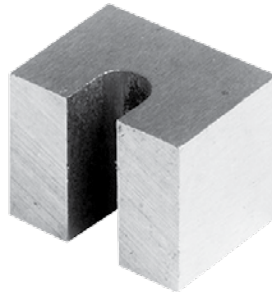
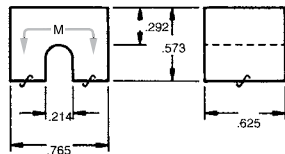

U-Shaped Cast Alnico 5

Part No.	Wt. (lbs)	Holding Force (lbs)
CU612	0.19	11

Pole faces ground

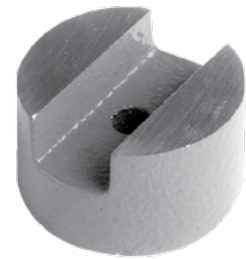
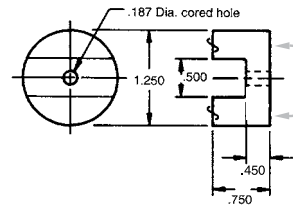

U-Shaped Cast Alnico 5

Part No.	Wt. (lbs)	Holding Force (lbs)
CU610	0.27	19

Pole faces ground

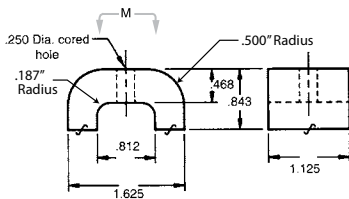

U-Shaped Cast Alnico 5

Part No.	Wt. (lbs)	Holding Force (lbs)
CU620	0.71	34

Pole faces and back ground

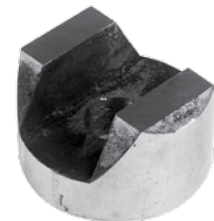
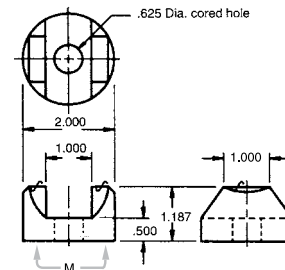

Permanent Magnetic Materials

Alnico



U-Shaped Cast Alnico 5

Part No.	A	B	C	D	E	G	Wt. (lbs)	Holding Force (lbs)
CU616	.875	.875	.437	.310	.406	.250	0.10	9
CU617	1.000	1.000	.500	.354	.406	.265	0.15	12
CU618	1.375	1.375	.687	.487	.495	.312	0.42	13

Pole faces ground

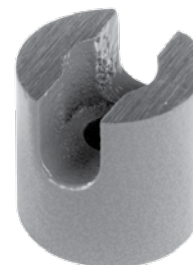
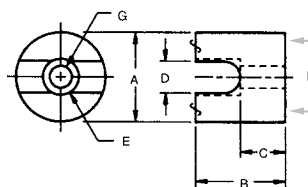

U-Shaped Cast Alnico 5

Part No.	A	B	C	D	E	F	Wt. (lbs)	Holding Force (lbs)
CU634	.492	.177	.185	.374	.157	.283	0.16	1.545
CU635	.752	.189	.250	.500	.220	.343	0.05	4.189
CU636	1.000	.189	.315	.626	.220	.343	0.12	7.496

Pole faces ground

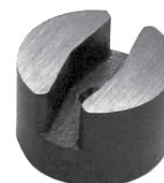
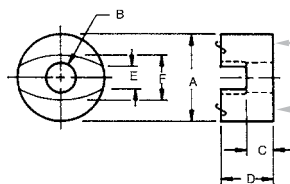

Horseshoe Cast Alnico 5

Part No.	D	E	F	G	H	T	W	Wt. (lbs)	Holding Force (lbs)
CH704	.141	.562	.375	.750	1.313	.375	1.500	0.13	14.0
CH705	.172	.656	.438	.875	1.531	.438	1.750	0.21	19.0
CH706	.188	.750	.500	1.000	1.750	.500	2.000	0.32	25.0

Pole faces ground

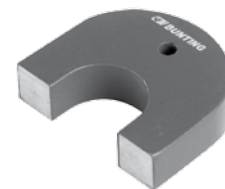
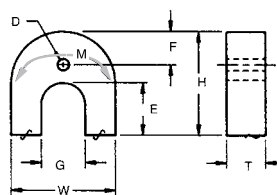

Horseshoe Cast Alnico 5

Part No.	A	B	C	D	E	R	r	Wt. (lbs)	Holding Force (lbs)
CH750	1.094	.719	.250	.422	.344	.562	.250	0.21	6.5

Pole faces ground

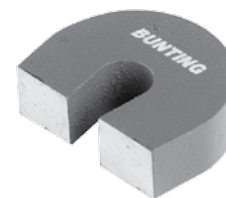
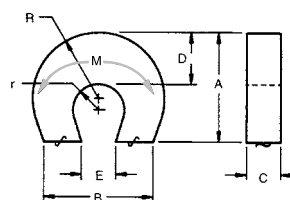

* All measurements are in inches.

** DOM – Direction of magnetization – indicated by gray arrows.

• Unless otherwise specified, magnets will be furnished in magnetized condition.

• Holding forces are approximate. These are average values obtained under laboratory conditions. Size, shape, and material of the test piece may affect actual pull forces.

Permanent Magnetic Materials

Alnico

Channel Cast Alnico 5

Part No.	A	C	D	F	H	L	R	Wt. (lbs)	Holding Force (lbs)
CC800	.500	.225	.165	---	.484	6.000	---	0.32	35
CC801	1.000	.375	.156	.812	6.000	.141	1.01	96	96

Pole faces ground

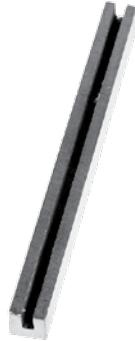
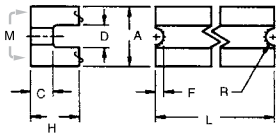

Tech Tip

Alnico Channels can be used for holding applications in ovens and furnaces up to 1000° F.

Channel Cast Alnico 5

Part No.	A	C	D	H	L	Wt. (lbs)	Holding Force (lbs)
CC804	.625	.250	.250	.500	6	0.39	25
CC806	1.000	.375	.375	.750	6	0.93	41
CC807	1.250	.500	.438	1.000	6	1.63	108

Pole faces ground

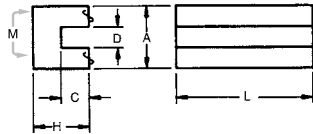

Channel Cast Alnico 5

Part No.	A	C	D	E	F	H	L	Wt. (lbs)	Holding Force (lbs)
CC810	.580	.188	.156	.625	.170	.445	4.750	0.26	25

Pole faces and back ground

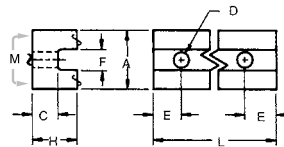

* All measurements are in inches.

** DOM - Direction of magnetization - indicated by gray arrows.

• Unless otherwise specified, magnets will be furnished in magnetized condition.

• Holding forces are approximate. These are average values obtained under laboratory conditions. Size, shape, and material of the test piece may affect actual pull forces.

Permanent Magnetic Materials

Alnico



Channel Cast Alnico 5

Part No.	Wt. (lbs)	Holding Force (lbs)
CC812	0.37	27

Pole faces ground

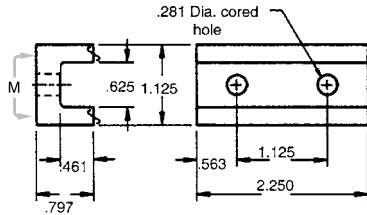

Channel Cast Alnico 5

Part No.	Wt. (lbs)	Holding Force (lbs)
CC816	0.14	9

Pole faces ground

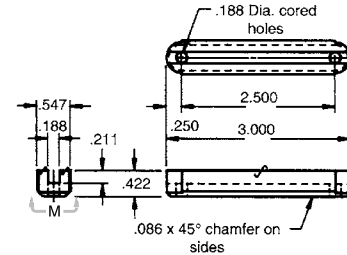

Channel Cast Alnico 5

Part No.	A	B	C	Wt. (lbs)	Holding Force (lbs)
CC814	1.125	1.000	3.250	0.43	35

Pole faces ground

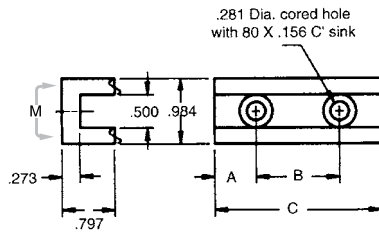

Channel Cast Alnico 5

Part No.	Wt. (lbs)	Holding Force (lbs)
CC817	.76	45

Pole faces and ends ground

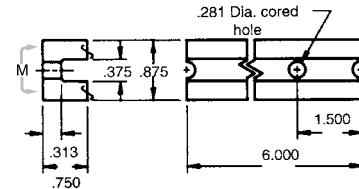

Channel Cast Alnico 5

Part No.	Wt. (lbs)	Holding Force (lbs)
CC815	1.31	75

Pole faces ground

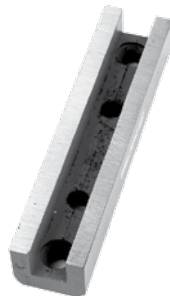
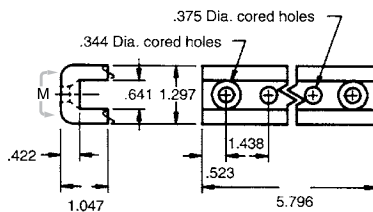

Tech Tip

Did you know that Alnico magnets offer the highest maximum operating temperature of any magnet material (1000°F)?

* All measurements are in inches.

** DOM - Direction of magnetization - indicated by gray arrows.

• Unless otherwise specified, magnets will be furnished in magnetized condition.

• Holding forces are approximate. These are average values obtained under laboratory conditions. Size, shape, and material of the test piece may affect actual pull forces.

Permanent Magnetic Materials

Alnico

Side Pole Rotor Cast Alnico 5

Part No.	Alnico Grade	No. Poles	A	B	C	D	E	F	Wt. (lbs)	Holding Force (lbs)
SP940	5	4	.750	.250	1.000	.500	.500	.250	0.12	18
SP941	5	6	1.250	.375	1.813	.750	.625	.313	0.71	50
SP942	5	8	1.250	.375	2.000	1.000	.875	.500	0.82	75
SP947	5	6	.750	.219	1.250	.625	---	.250	0.16	30

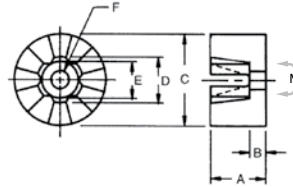
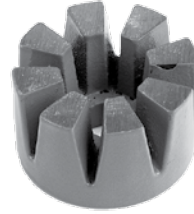

Ring Cast Alnico 5

Part No.	A	B	C	Wt. (lbs)
CR1401	0.717	0.315	.312	0.05
CR1407	1.405	0.850	.500	0.13
CR1411	1.530	0.500	.375	0.16

Optional magnetization along diameter

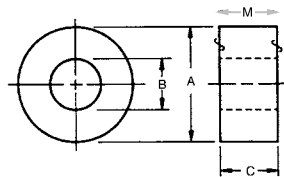

Tech Tip

On the Side Pole Rotor, the alternating poles (used with a sensor) can be used as a counter or to monitor RPM.

Ring Cast Alnico 5

Part No.	A	B	C	Wt. (lbs)	Holding Force (lbs)	
					2 Poles 1 Face	Straight Thru
CR1424	0.500	0.125	0.250	0.02	1.6	0.2
CR1429	1.000	0.750	0.500	0.04	3.5	1.4
CR1430	1.500	1.125	0.750	0.15	8.0	3.0
CR1431	2.000	1.500	1.000	0.38	13.0	6.0

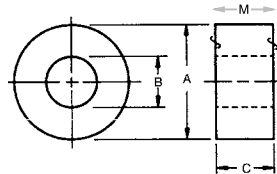

* All measurements are in inches.

** DOM – Direction of magnetization – indicated by gray arrows.

• Unless otherwise specified, magnets will be furnished in magnetized condition.

• Holding forces are approximate. These are average values obtained under laboratory conditions. Size, shape, and material of the test piece may affect actual pull forces.

Permanent Magnetic Materials

Alnico



Round Bar Cast Alnico 8 B

Part No. B	D	L	Wt. (lbs)
R-910-4	.125	4	0.01
R-915-4	.187	4	0.03
R-920-4	.250	4	0.05
R-930-4	.375	4	0.12
R-945-4	.500	4	0.21
R-950-4	.625	4	0.33
R-960-4	.750	4	0.48
R-970-4	.875	4	0.65
R-980-4	1.000	4	0.84

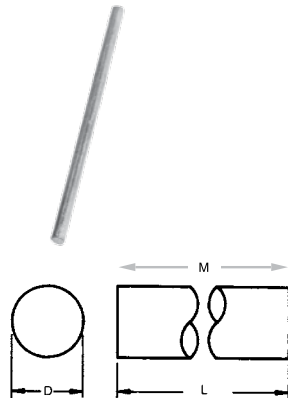

Rod Sintered Alnico 8H

Part No.	D	L	Wt. (oz)
SR-8103	.120	.187	0.21
SR-8105	.120	.375	0.02
SR-8106	.124	.250	0.03
SR-8108	.250	.375	0.09

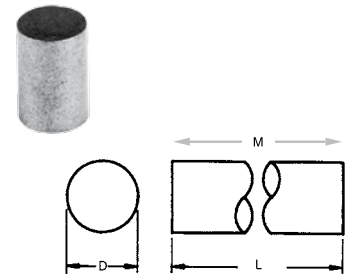

Centerless Ground Bar Cast Alnico 8

Part No. B	D	L	Wt. (lbs)
CG-905-4	.093	4	0.67
CG-910-4	.125	4	0.12
CG-915-4	.187	4	0.03
CG-920-4	.250	4	0.05
CG-925-4	.312	4	0.08
CG-930-4	.375	4	0.12
CG-935-4	.437	4	0.16
CG-940-4	.500	4	0.21
CG-950-4	.625	4	0.32
CG-960-4	.750	4	0.47
CG-975-4	.983	4	0.80

Ground diameter (+.002 - .000)



Rectangular Bar Sintered Alnico 8H

Part No.	A	B	L	Wt. (oz)
Oriented through 'A' dimension				
SB-8002	.250	.375	1.000	0.46
SB-8004	.375	.250	1.000	0.23
Oriented through 'L' dimension				
SB-8010	.125	.125	0.375	0.03
SB-8012	.125	.250	0.500	0.07

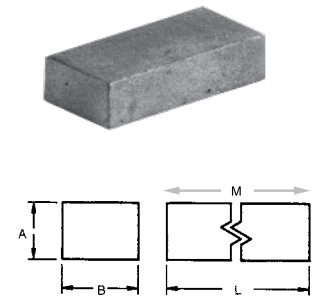

Ring Sintered Alnico 8H

Part No.	A	B	T	Wt. (lbs)
SD-8202	.312	.130	.125	0.04
SD-8205	.525	.250	.150	0.13

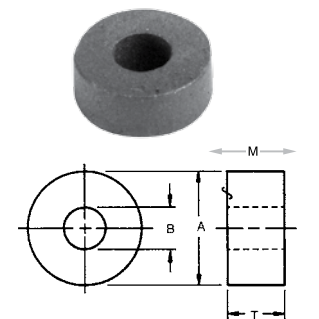

Square Bar Cast Alnico 8 HE

Part No.	A	L	Wt. (lbs)
BS-800-4	0.125	4	0.02
BS-820-4	0.250	4	0.06
BS-880-4	1.000	4	0.89

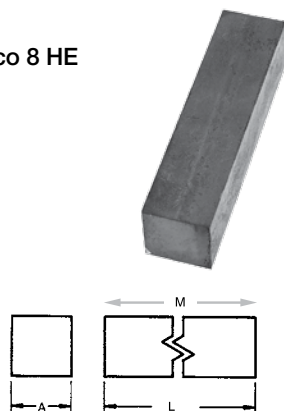

Disc Sintered Alnico 8H

Part No.	D	L	Wt. (oz)
SP-8301	.125	.062	0.01
SP-8302	.125	.125	0.01
SP-8303	.125	.250	0.01
SP-8304	.250	.062	0.01
SP-8305	.250	.125	0.02
SP-8306	.250	.250	0.02
SP-8307	.375	.125	0.01
SP-8308	.375	.250	0.01
SP-8309	.375	.375	0.02
SP-8310	.500	.125	0.02
SP-8311	.500	.250	0.01
SP-8312	.500	.500	0.03

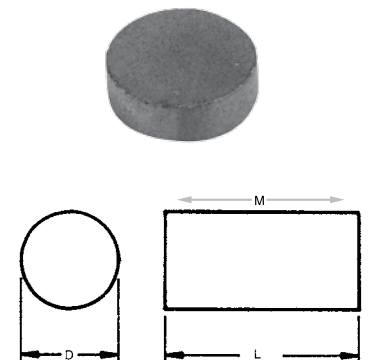

Permanent Magnetic Materials

Alnico

U-Shaped Rectangle Sintered Alnico 2

Part No.	A	B	C	D	E	F	Wt. (lbs)	Holding Force (lbs)
SU1602*	.281	.750	.375	.135	.250	.188	0.02	1.063
SU1603	.375	.875	.375	.120	.250	.203	0.03	1.438

* Tolerances
 Min. Tol. A: ± .005
 C: - .020
 Max. Tol. E: + .020

Shipped in pairs

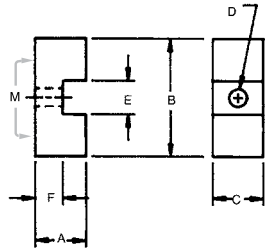
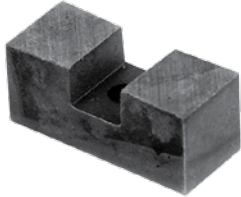

Ring Sintered Alnico 2

Part No.	Wt. (lbs)	Holding Force (lbs)
SD1703	0.01	.094

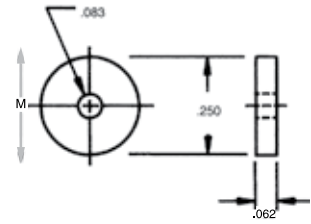
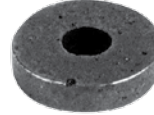

Ring Sintered Alnico 2

Part No.	A	B	C	Wt. (lbs)	Holding Force (lbs)
SD1705	.500	.182	.166	0.02	.813
SD1706	.510	.105	.128	0.02	.438

Ground on faces

Poles ground

Magnetized as 2 pole rotor along the diameter

Shipped in pairs

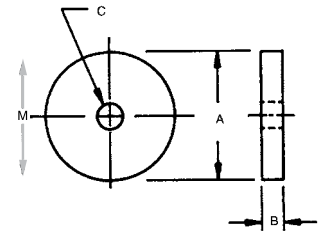

U-Shaped Round Sintered Alnico 2

Part No.	A	B	D	E	F	G	R	Wt. (lbs)	Holding Force (lbs)
SU1606	.400	.202	.114	.099	.098	.130	.086	0.02	.438
SU1607	.400	.187	.109	.099	.098	.130	.086	0.02	.750

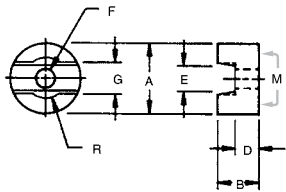
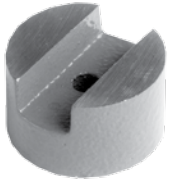

U-Shaped Round Sintered Alnico 2

Part No.	A	B	D	F	G	Wt. (lbs)	Holding Force (lbs)
SU1610	.500	.457	.325	.101	.187	0.02	1.125
SU1611*	.500	.442	.317	.101	.187	0.02	1.563
SU1612	.500	.265	.130	.101	.187	0.01	0.813
SU1613*	.500	.245	.119	.101	.187	0.01	0.875

* Pole faces and back ground

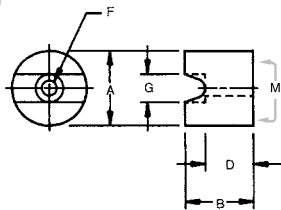
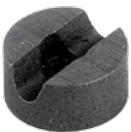

* All measurements are in inches.

** DOM – Direction of magnetization – indicated by gray arrows.

• Unless otherwise specified, magnets will be furnished in magnetized condition.

• Holding forces are approximate. These are average values obtained under laboratory conditions. Size, shape, and material of the test piece may affect actual pull forces.

Ceramic Magnets • Grades 5 & 8

Economical Magnets Stocked for a Wide Range of Applications



Ceramic Grades 5 & 8 have become the most widely specified magnetic materials. Low cost, light weight, a relatively high energy product, and good resistance to demagnetization account for the widespread use of Ceramic magnets.

Ceramics are sintered from Strontium Ferrite. They retain about 70 percent of their room-temperature magnetic specifications at 350° Fahrenheit. Degradation with increasing temperature is nearly linear, and changes in magnetization are essentially reversible up to approximately 480°F, at which temperature Ceramic magnets become completely demagnetized.

Ceramic magnetic material is very hard and brittle and should be cut before it is magnetized. It should never be used as a structural element in a holding assembly. Holes cannot be drilled in ceramic, but shaping and sizing can be successfully accomplished with the right equipment and expertise. Thanks to our precision cutting and slicing equipment, we can offer you a wide selection of standard shapes and sizes. We can also cut to your specifications and tolerances.

Ceramic 5 Magnets become highly oriented during the manufacturing process and must be magnetized in the direction of their orientation.

Ceramic 8 Magnets are made from a premium strontium base material that exhibits an excellent peak energy product and even greater resistance to demagnetization than its Ceramic 5 counterpart. Its higher coercive properties result in a more useful operating slope. Like Ceramic 5, it is a highly oriented material and must be magnetized in the direction of orientation.

Ceramic 8 is an excellent choice wherever magnet length is at a minimum or where the magnetic circuit is subject to severe demagnetizing fields. Some typical uses include holding magnets, motors, reed switches, and Hall-Effect devices.

Demagnetization Curves for Ceramic 5 & 8 Magnets

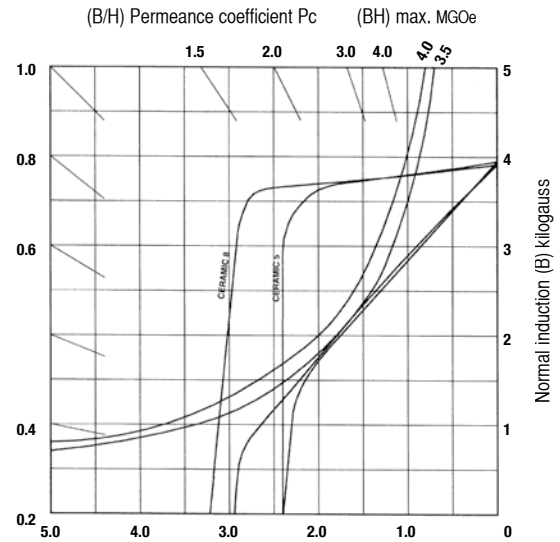

Dimensional Tolerances:
 Thickness & Diameter ± .005"
 Width & Length ± .015" or 2% (whichever is greater)

Permanent Magnetic Materials

Ceramic

Ring Ceramic 8

Part No.	A	B	C	Holding Force (lbs)
R2410	.500	.125	.187	.30
SF-803AM	.550	.200	.231	.71
R2510	.551	.078	.197	.15
R2409	.750	.250	.271	1.00
R2406	1.623	.167	.705	.57

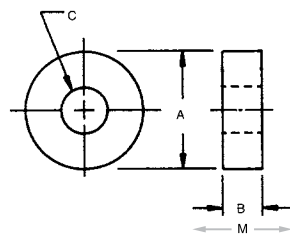

Disc Ceramic 8

Part No.	A	B	Holding Force (lbs)
SF-804AM	.375	.200	.50
DH915	.472	.197	.65
DH911	.500	.200	.69
DH916	.701	.197	.99
DH912	.710	.200	1.00
SF-808AM	.750	.250	1.30
MA365	.883	1.000	1.70
DH917	.970	.156	.96
SF-802AM	.980	.260	1.70

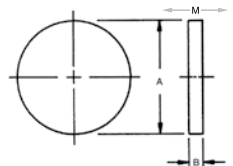
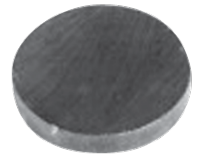

- * All measurements are in inches.
- ** DOM - Direction of magnetization - indicated by gray arrows.
- Unless otherwise specified, magnets will be furnished in magnetized condition.
- Holding forces are approximate. These are average values obtained under laboratory conditions. Size, shape, and material of the test piece may affect actual pull forces.

Permanent Magnetic Materials

Ceramic

Block Ceramic 8

Part No.	A	B	C	Holding Force (lbs)
MA370	.093	.785	2.000	0.5
MA415	.106	.785	10.625	0.8
MA460	.125	1.000	2.000	0.9
MA480	.187	1.000	2.000	1.7
MA490	.187	1.000	10.625	2.4
MA540	.250	.219	.344	0.4
MA550	.250	.219	.219	0.3
MA560	.250	.375	.375	0.7
MA570	.250	.375	.500	0.8
MA610	.250	2.000	3.000	3.4
MA620	.250	.875	1.875	2.5
MA640	.250	1.000	2.000	2.6
MA680	.312	1.000	2.000	3.5
MA740	.375	1.000	2.000	4.4
MA760	.392	.406	1.875	2.9
MA800	.392	.875	.906	2.9
MA820	.392	.875	1.875	4.2
MA820H*	.392	.875	1.875	4.2
MA825	.395	.125	2.000	1.5
MA845	.395	.375	2.000	3.0
MA850	.395	.500	2.000	3.4
MA860	.395	.531	2.000	3.5
MA865	.395	.625	2.000	3.8
MA867	.395	.531	10.500	7.9
MA880	.395	.688	2.000	4.0
MA883	.395	.688	10.500	8.2
MA885	.395	.750	2.000	4.1
MA890	.395	.875	2.000	4.4
MA900	.395	1.000	.438	2.0
MA920	.395	1.000	2.000	4.6
MA940	.395	1.000	10.500	8.6
MA1000	.500	1.000	2.000	6.0
MA1010	.500	3.500	10.625	14.9

Part No.	A	B	C	Holding Force (lbs)
MA1226	.500	4.000	6.000	13.5
MA1020	.750	1.000	2.000	9.0
MA1025	.750	1.000	10.500	21.6
MA1040	.750	1.719	3.532†	15.5
MA1045	.750	3.532	10.625	28.8
MA1227	.750	4.000	6.000	25.3
MA1048	1.000	.250	2.000	3.6
MA1056	1.000	.500	2.000	6.2
MA1058	1.000	.625	2.000	7.4
MA1065	1.000	.750	2.000	8.4
MA1070	1.000	.750	10.500	26.8
MA1085	1.000	.875	2.000	9.4
MA1100	1.000	1.000	2.000	10.3
MA1109	1.000	1.000	6.000	21.6
MA1110	1.000	1.000	10.500	30.1
MA1115	1.000	1.125	2.000	11.1
MA1117	1.000	1.178	1.178	7.8
MA1143	1.000	1.250	2.000	11.9
MA1146	1.000	1.375	2.000	12.7
MA1149	1.000	1.500	2.000	13.4
MA1152	1.000	1.625	2.000	14.1
MA1160	1.000	1.719	3.532†	20.7
MA1170	1.000	1.719	10.500†	36.2
MA1175	1.000	2.000	10.500	37.9
MA1180	1.000	2.063	1.563	14.1
MA1183	1.000	2.418	10.500	40.0
MA1185	1.000	2.563	3.125	23.7
MA1225	1.000	3.532	10.625	44.2
MA1228	1.000	4.000	6.000	37.6

* 2 Countersunk holes

† Tolerance $\pm 1\frac{1}{2}\%$ this dimension

NOTE: Special size blocks available on request

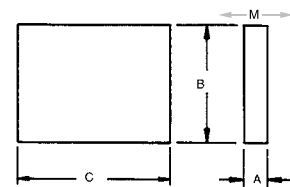

Rectangle With Hole Ceramic 5

Part No.	A	B	C	D	Holding Force (lbs)
DH914	1.000	.750	.177	.187	1.0

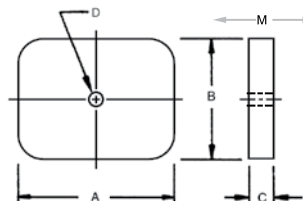
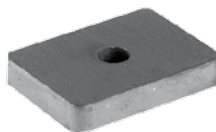

Flexible Magnetic Strips and Sheets

Bend it. Twist it. Cut, slit, punch, drill, or stamp it.



Bunting® Flexible Magnetic Strips conform to irregular shapes and provide holding power superior to conventional magnets on uneven metal surfaces. You can cut or form them easily without cracking or loss of magnetic energy. They're light in weight and can be removed, reused, bent, or twisted again and again. Their flexibility and magnetic strength make them ideal where rigid, brittle, or electrically conductive materials can't be used.

Applications include latches or catches, gaskets, door seals, tool holders, and holding fixtures. For signs, charts, displays, shelf labeling, and novelties, they're a reusable alternative to adhesive or fasteners. They can also be used in switches or sensing devices or to dampen noise and vibration.

Bunting® Magnetic Strips are sold by the foot, so you can order exactly what you need. Perhaps best of all, they cost less than most other magnetic materials. And our large, centrally located inventory ensures that what you need will be in stock for immediate shipment.

Custom Fabrication Services

Bunting® Magnetics Co. can convert Flexible Magnetic Strips to meet your requirements.

Custom Slit-To-Width

If you don't find the width of magnet you need from our stock inventory, Bunting® can slit Flexible Magnets of various standard thicknesses to the widths indicated in the chart at the right. Refer to this chart to select the right magnet thickness for the strip width you require.

Magnetic Properties

	Max Energy Prdct (BdHd)	Residual Induction	Coercive Force (Hc)
Type A & N, SE*	0.70	1650	1350
Type A & N, HE**	1.40	2450	2070
Type W (with Nitrile)	1.40	2450	2200
Type S and D	0.65	1650	1350

* SE = Standard Energy ** HE = High Energy

Physical Properties

	Density (lb/in ²)	Hardness (shore D)	Tensile Strength (PSI)	Ultimate Elongation (Pct)	Temperature Limits (°F)
Type A & N, SE*	.130	50	875	40	0 to 150
Type A & N, HE**	.130	50	875	40	-20 to 160
Type W (with Nitrile)	.134	55	640	18	-40 to 300
Type S and D	.130	50	875	40	0 to 150

Custom Cut-To-Length

Bunting® can cut or score Flexible Magnetic Strips to your specifications. Refer to the diagrams below to select the cutting or scoring method you prefer.

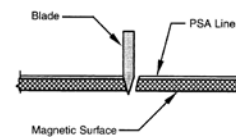

Magnetic Strip Cutting Capabilities

CP Cut Part

Cutting blade severs all substrates. Strip is cut into individual pieces.

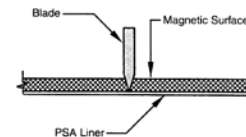

CTM Cut Through Magnet

Cutting blade cuts completely through magnet and PSA adhesive but leaves the PSA liner intact. Cut pieces are peeled from the liner.

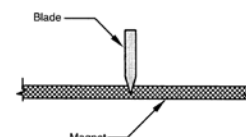

STM Score Through Magnet

Cutting blade cuts 3/4 of the thickness of the magnetic strip. The strip can be broken into cut pieces by bending at the score.

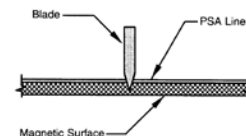

STP Score Through Paper

Cutting blade cuts PSA paper carrier, adhesive layer, and penetrates 3/4 of the thickness of the magnetic strip. The strip can be broken into cut pieces by bending at the score.

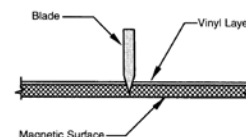

STV Score Through Vinyl

Cutting blade cuts colored vinyl top coating and penetrates 3/4 of the thickness of the magnetic strip. The strip can be broken into cut pieces by bending at the score.

THICKNESS	0.250	0.375	0.500	0.750	1.00	1.50	2.00	3.00
0.250	NO	NO	NO	NO	NO	NO	NO	NO
0.188	NO	NO	NO	NO	NO	YES	YES	YES
0.120	NO	NO	NO	NO	YES	YES	YES	YES
0.090	NO	NO	NO	YES	YES	YES	YES	YES
0.060	NO	NO	YES	YES	YES	YES	YES	YES
0.030	NO	NO	NO	YES	YES	YES	YES	YES

NOTE: Stock Tooling in 1/16" increments. Intervals of 1/32" can be accommodated. Tolerances: Thickness ± .005"
 Width 0-1" = ± .020"
 1-2" = ± .030"
 2-3" = ± .050/- .030"
 Cut Length (custom cut) ± 1% or ± .010" whichever is greater.

Flexible Magnetic Strips and Sheets

Bend it. Twist it. Cut, slit, punch, drill, or stamp it.

Magnetization Patterns

Magnets with a **conventional magnetization pattern** have a single, equal strength pole on each opposite face.

Magnets with a **multipole magnetization pattern** on both sides have multiple poles along both faces. The magnetic force is of equal strength on both sides.

Magnets with a **two-pole or multipole magnetization pattern** have two or more poles on one face of the magnet. This pattern creates a greater concentration of magnetic strength on that face.

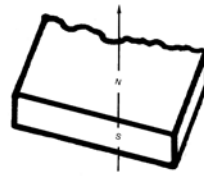

Conventional

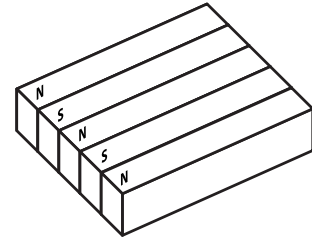

Multi-Pole, One Face

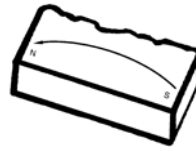

Two Poles
One Face

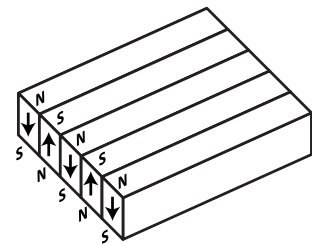

Multi-Pole, Both Face

Adhesives

Bunting® can laminate Flexible Magnetic Strips with a variety of adhesives. See below for more information.

Adhesives Options

PSA-HR: High-performance rubber-based, pressure-sensitive adhesive custom formulated for use with magnetic strip material. It has good adhesion and high initial tack qualities. High temperatures and plasticizers can soften this adhesive.

PSA-AC: General-purpose acrylic-based, pressure-sensitive adhesive that resists moderate amounts of plasticizer in plastics and PVC. Greater temperature and chemical resistance than rubber-based adhesives. Acrylic-based adhesives have lower initial tack but higher ultimate performance after a cure time of 24 hours. This adhesive is available on special order only and is not normally stocked.

PSA-F: High-performance acrylic-adhesive custom formulated for use with magnetic strip material. Adhesive features $\frac{1}{32}$ " thick polyethylene foam and is recommended for use on rough or irregular surfaces. This adhesive is available by special order only and is not normally stocked.

Vinyls

Bunting can laminate Flexible Magnetic Strips with vinyls. White vinyl is standard. Red, orange, yellow, gold, black, blue, green, and silver vinyls are also available for larger custom runs.

Flexible Magnetic Strips and Sheets

Bend it. Twist it. Cut, slit, punch, drill, or stamp it.



Bunting® Type W Flexible Magnetic Strips

With Equal Holding Power on Both Sides

Bunting® Type W Flexible Magnetic Strips are a rubber-bonded composite consisting of oriented ferrite in a dark brown or Nitrile binder. They can be supplied with multipole or conventional magnetization and provide equal magnetic strength on both sides. See page 19 for more information. Multipole magnetization is standard.

Bunting® can cut or score this material to the length you require. We also offer other custom fabrication services. See page 18 for more information.

Bunting® Type S Flexible Magnetic Sheets

With Maximum Holding Power on One Side

Bunting® Type S Flexible Magnetic Sheets consist of ferrite in a dark brown thermoplastic binder. They feature multipole magnetization for maximum magnetic strength on one side. See page 19 for more information.

Type S Flexible Magnetic Sheets are available from stock as plain sheets, with pressure-sensitive adhesive, or with a variety of color vinyl laminates. Colors include gloss white, high-gloss white, red, orange, yellow, gold, black, blue, green, and silver.

Sheets can become distorted, especially at high temperatures, and should be stored flat or rolled with the magnetized side in.



Part No.	Size T x W (inches)	Coil Length (ft)	Poles Per Inch	Max. Lbs Pull Per Foot	Wt. Per Ft. (lbs)
MA1440	.030 x 3.00	100	18	36	.145
MA1460	.060 x 3.00	100	11	50	.289
MA1480	.093 x 3.00	75	6	55	.434
MA1500	.125 x 3.00	50	4	58	.603
MA1520	.187 x 3.00	5	4	62	.902
MA1540	.250 x 3.00	5	4	91	1.201

Tolerances: Thickness .030-.060" = ± .005", .093-.187" = ± .007", .250-.312" = ± .010"; Width ± .030"

(Above part numbers can be magnetized multipole or conventional)

- All Type W material uses a nitrite binder.
- See "Magnetization Patterns" on page 19.
- Pull strength on bare metal at zero air gap - magnetized with multipole pattern.

Part No.	Size T x W (inches)	Coil Length (ft)	Poles Per Inch	Max. Lbs Pull Per Sq. Ft.***	Color	Wt. Per Ft. (lbs)
MA1690	.020 x 24.375 w/PSA	50	14	70	Natural	.95
MA1695	.025 x 24.375	50	14	70	Gloss White	.95
MA1700	.030 x 24.375	50	12	100	Natural	1.17
MA1710	.030 x 24.375	50	12	100	Gloss White	1.23
MA1720*	.030 x 24.375	50	12	100	Hi-Gloss White	1.23
MA1760	.060 x 24.375	50	10	130	Gloss White	2.46

Tolerances: Thickness ± .002"; Width ± .063"

* Laminate colors on one side. Gloss colors include: Red, Orange, Yellow, Gold, Black, Blue, Green, and Silver. Natural color is Brown rubber.

- See "Magnetization Patterns" on page 19.
- Pull strength on bare metal at zero air gap.

Bunting® Type D Specialty Magnets

Bunting Type D Specialty Magnets are available as Business Card Magnets with pressure-sensitive adhesive backing to adhere to your business card.

Part No.	Size T x W (inches)	Magnetization Pattern	Max. Lbs Pull Per Foot
MA1650 (Bus Cards)*	.015 x 2 x 3.5	Multipole	.98

-- With pressure-sensitive adhesive.

-- Sold in packets of 25.



Flexible Magnetic Strips and Sheets

Bend it. Twist it. Cut, slit, punch, drill, or stamp it.

Bunting® Type A Flexible Magnetic Strips

With Maximum Holding Power on One Side and Pressure-Sensitive Adhesive Backing

Bunting® Type A Flexible Magnetic Strips consist of ferrite in a dark brown thermoplastic binder. One side is coated with a high-tack, pressure-sensitive adhesive.

Type A Flexible Magnetic Strips feature multipole magnetization for maximum magnetic strength on the side opposite the adhesive.

Bunting® can cut or score this material to the length you require. We also offer other custom fabrication services.

Part No.	Size T x W (inches)	Coil Length (ft)	Pole Spacing (inches)	Max. Lbs Pull Per Foot**	Adhesive Grade	Wt. Per Ft. (lbs)
Standard Energy						
MA1235	.030 x .500	200	.100	4.0	PSA-HR	.023
MA1236	.030 x .750	200	.100	6.0	PSA-HR	.035
MA1237	.030 x 1.00	200	.100	8.0	PSA-HR	.047
MA1240	.060 x .500	100	.100	6.0	PSA-HR	.047
MA1241	.060 x .750	100	.100	9.0	PSA-HR	.070
MA1242	.060 x 1.00	100	.100	12.0	PSA-HR	.094
MA1243	.060 x 1.50	100	.100	18.0	PSA-HR	.140
MA1244	.060 x 2.00	100	.100	24.0	PSA-HR	.187
MA1248	.120 x .500	50	.187	8.0	PSA-HR	.094
MA1249	.120 x .750	50	.187	12.0	PSA-HR	.140
MA1250	.120 x 1.00	100	.187	16.0	PSA-HR	.187
MA1260	.120 x 3.00	50	.187	48.0	PSA-HR	.562
High Energy						
MA1270	.060 x .250	100	.125	4.5	PSA-HR	.023
MA1280	.060 x .500	100	.125	9.0	PSA-HR	.047
MA1285	.060 x .750	100	.125	13.5	PSA-HR	.070
MA1290	.060 x 1.00	100	.125	18.0	PSA-HR	.094
MA1292	.060 x 1.25	100	.125	22.5	PSA-HR	.117
MA1295	.060 x 1.50	100	.125	27.0	PSA-HR	.140
MA1800	.060 x 2.00	100	.125	36.0	PSA-HR	.187
MA1900	.060 x 3.00	100	.125	54.0	PSA-HR	.281
MA1380E	.125 x .500	50	.250	12.0	PSA-HR	.098
MA1910	.125 x .500	50	.187	12.0	PSA-HR	.098
MA1915	.125 x .750	50	.187	18.0	PSA-HR	.146
MA1920	.125 x 1.00	50	.187	24.0	PSA-HR	.195
MA1930	.125 x 3.00	50	.187	72.0	PSA-HR	.585

PSA-HR adhesive adds .0045" additional thickness.

Temperature range of adhesive 0-150° F

Bunting® Type N Flexible Magnetic Strips

With Maximum Holding Power on One Side

Bunting® Type N Flexible Magnetic Strips consist of ferrite in a dark brown thermoplastic binder. They feature multipole magnetization for maximum magnetic strength on one side.

Bunting® can cut or score this material to the length you require. We also offer other custom fabrication services.

Part No.	Size T x W (inches)	Coil Length (ft)	Pole Spacing (inches)	Max. Lbs Pull Per Foot**	Wt. Per Ft. (lbs)
Standard Energy					
MA1294	.030 x 2.00	100	.100	16.0	.094
MA1296	.030 x .500	200	.100	4.0	.023
MA1297	.030 x .750	200	.100	6.0	.035
MA1298	.030 x 1.00	200	.100	8.0	.047
MA1299	.030 x 3.00	200	.100	24.0	.140
MA1300	.060 x .500	100	.100	6.0	.047
MA1310	.060 x .750	100	.100	9.0	.070
MA1320	.060 x 1.00	100	.100	12.0	.094
MA1325	.060 x 2.00	100	.100	24.0	.187
MA1330	.060 x 3.00	100	.100	36.0	.281
MA1345	.093 x 1.50	100	.125	21.8	.218
MA1350	.093 x 3.00	100	.125	43.5	.435
MA1360	.085 x 1.00	100	.250	14.0	.133
MA1369	.085 x 3.00	100	.250	42.0	.398
MA1380	.120 x .500	50	.187	8.0	.094
MA1395	.120 x 1.00	100	.187	16.0	.187
MA1399	.120 x 3.00	50	.187	48.0	.562
MA1400K *	.187 x 1.00	50	.250	18.0	.292
MA1415	.187 x 3.00	50	.250	54.0	.875
MA1420	.250 x .625	100	.250	13.0	.244
High Energy					
MA1801	.060 x .500	100	.10	9.0	.047
MA1802	.060 x .750	100	.100	13.5	.071
MA1803	.060 x 1.00	100	.100	18.0	.094
MA1810	.060 x 3.00	100	.125	54.0	.281
MA1811	.125 x .500	100	.187	12.0	.098
MA1812	.125 x .750	100	.187	18.0	.147
MA1813	.125 x 1.00	100	.187	24.0	.195
MA1830	.125 x 3.00	50	.187	72.0	.585

Footnotes for Tables Type A and Type N

See page 18 for dimensional tolerances.

- Magnetization Pattern on MA1380E is two poles each face.
- Pull Strength on bare metal at zero air gap.

Approximate figures based upon 1" wide material.

* Special magnet pattern S-N-N-S



Permanent Magnetic Holding Assemblies

Alnico, Ceramic, and Rare Earth



Put Permanent Magnetic Power to Work in Your Plant with Alnico, Ceramic, and Rare Earth Permanent Magnetic Holding Assemblies from Bunting® Magnetics

Bunting® Magnetic Holding Assemblies are versatile, labor-saving tools for holding, moving, stabilizing, and feeding ferrous materials and parts throughout your production and handling operations. Bunting® Holding Assemblies are utilized in many ways in many industries. We couldn't begin to name all the possible uses for these economical permanent magnetic assemblies. In fact, our customers are our best source of new ideas for holding magnet applications.

Order Standard or Custom Assemblies for All Your Part Holding and Material Handling Applications

We produce and stock hundreds of standard configurations, sizes, and types of Permanent Magnetic Holding Assemblies. In addition, we can build to order and fabricate custom assemblies to meet your special needs and specifications. Whatever your individual needs, we'll be glad to discuss your requirements, submit design recommendations, and provide a quote. See page 23 for more information on Bunting® Custom Magnetic Holding Assemblies.

Magnetic Selection

Here's How to Select the Holding Assemblies You Need

Begin by asking yourself the following questions. Your answers will point you in the right direction to find the assemblies that meet your specifications. If you want further advice after reading the following prompts, we'll be glad to help you. Just call us and describe your application.

What are your shape and size requirements and mounting restrictions?

The Magnetic Holding Assemblies in this catalog are arranged by shape and size. Once you've determined what limitations your design imposes and answer some other questions, you can start your search by going to the Table of Contents and looking up the shape(s) that fit. Turn to the appropriate section, and you'll find the standard stock sizes listed for each shape.

Is the mounting surface magnetic or nonmagnetic?

Certain holding assemblies need to be insulated for maximum holding effectiveness when mounted in ferrous materials. Call for more information.

How will your assemblies be mounted?

Press-fit mountings may require special insulation in ferrous materials. Place the uninsulated holding assembly inside a tight-fitting stainless steel, aluminum, or other nonmagnetic sleeve and install. For bolted mountings, you'll be looking for tapped or thru-hole assembly designs. Nonferrous fasteners are recommended for bolt-on applications.

What is the estimated holding force required for your application? What forces, in addition to gravity, will be acting on the parts while they are being held?

If you know how much your parts weigh and what other factors are likely to be involved, you can begin to make a rough estimate of how much holding power each individual magnet will need to have. In the parts listings, you'll find magnetic holding values for every standard assembly. These holding values have been established in controlled laboratory tests and indicate vertical pull from flat ground steel.

For example, an assembly with a holding value of 5 pounds can hold a 5-pound steel part with a flat ground surface on a vertical pull under laboratory conditions. But outside the laboratory, you need to consider more than the weight of the parts you will be handling.

The size and shape of parts, as well as their surface condition, motion, vibration, friction, holding angle, and machining forces need to be factored in. Anything that gets in the way of direct magnet-to-metal contact or creates an air gap will also create the need for more magnetic holding force.

What are the size, shape, and weight of the parts you're handling?

Use the size and shape of the parts to estimate the number of magnetic holding assemblies you'll need to hold each part in your application. From the number of magnets, weight of the parts, and factors such as the ones noted in this section, you can figure approximately how much each magnet will need to hold.

Permanent Magnetic Holding Assemblies

Alnico, Ceramic, and Rare Earth

Steel Plates, Cups and Channels Concentrate Magnetic Energy

The pull of conventionally magnetized strips can be increased and directed with a variety of iron or steel pole pieces. The metal forms paths of high magnetic conductivity, concentrating the total magnetic force where it is most useful. Four of the most common types of pole plates are shown, along with the direction of maximum magnetic force each provides.

Order by part number after selecting the type, size, and quantity you need.

Orders for custom sizes and small quantities are welcome.



Channel
Conventional
Magnetization

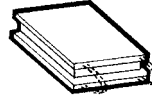

Sandwich
Conventional
Magnetization

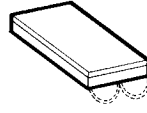

Back Plate
Conventional or
Multipole-Both
Sides Magnetization

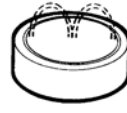

Disk
Conventional
Magnetization

Select the Right Magnet Material

Alnico Holding Assemblies are well-suited for high-heat applications. Alnico magnets have the widest range of temperature stability of any standard magnetic material. At temperatures as high as 840°F, they maintain about 78% of their room-temperature magnetic properties. Alnico assemblies are strongly recommended for use in temperature ranges from 180-800°F.

We recommend that these magnets be mounted with nonferrous fasteners and insulated when installed in ferrous materials to avoid holding value drops of 20% or more.

Ceramic Holding Assemblies provide a strong, stable magnetic field. The ceramic magnet material possesses high coercive force and resists demagnetization from heat, vibration, and electrical fields. Ceramic Assemblies are permanently embedded in epoxy plastic. They are typically more economical than Alnico assemblies and can be used in temperatures up to 180°F. Temperatures higher than 180°F can cause the standard epoxy that holds the magnet material to fail. Higher temperature epoxy is available on special order. Because Ceramic assemblies are virtually unaffected by demagnetizing fields, they are ideal for work holders on welding machines and other equipment with strong electric currents.

What is the condition of the part surfaces? Are they flat or curved, smooth or rough cast? Are they clean, oily, rusted, or painted? Tabulated holding values are based on direct contact with flat metal. Curved surfaces or anything that reduces surface contact or creates an air gap will result in the need for more powerful holding assemblies. As a general rule of thumb, factor in 25% more holding force for parts with slightly curved, rough, or painted surfaces, as well as heavily oiled parts. Parts with sharply curved surfaces and significantly reduced magnet-to-metal contact may require 100% or more additional holding power. We recommend experimenting to determine the holding values you require.

Will the parts be above or below the holding assemblies? Will the parts be held horizontally or will you need to factor in shear forces for vertical or inclined applications? Holding values are based on vertical "pulling power." To allow for shear forces, additional holding force may be required. Call Bunting Magnetics for specific information.

What will the temperature of the operating environment be? For temperatures above 180°F, select assemblies that use Alnico magnets. See the following sections on magnet materials for more temperature information.

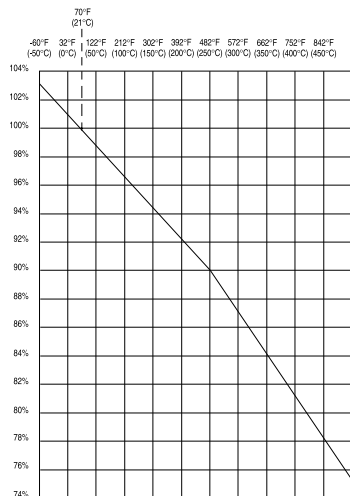

Graph is representative of typical Alnico Holding Assemblies. Specific holding values may vary.

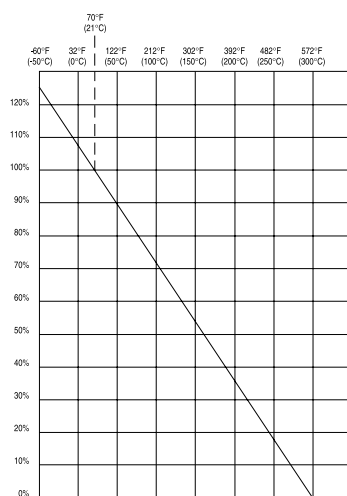

Graph is representative of typical Ceramic Holding Assemblies. Specific holding values may vary.

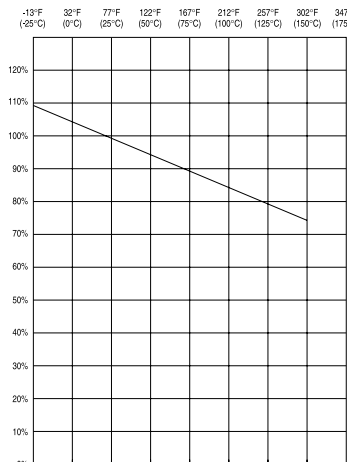

Graph is representative of typical Rare Earth Holding Assemblies. Specific holding values may vary.

Rare Earth Holding Assemblies offer the ultimate in holding strength. They deliver more magnetic power per ounce than any other assembly. They are well-suited to applications where size and weight must be kept to a minimum. Rare Earth Holding Assemblies are not intended for high-temperature applications and should not be used in environments above 180°F. Temperatures above this level can cause the epoxy plastic that surrounds the magnet material to fail.

Permanent Magnetic Holding Assemblies

Alnico, Ceramic, and Rare Earth



Holding Assemblies for Spot Welding Applications

Ceramic Holding Assemblies resist demagnetization by vibration and electrical fields. They are ideal for use as work holders on welding machines and other equipment with strong demagnetizing fields. Cylindrical Ceramic Holding Assemblies can be installed by a simple press fit with only a slight reduction in holding values.

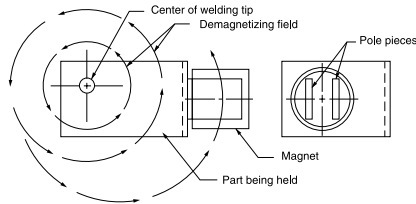

1. Install assemblies so that the demagnetizing field is parallel to the pole pieces, as illustrated.
2. Make sure that at least 50% of the holding assembly's length is outside the maximum demagnetizing field.

Mounting Magnets for Hold or Shear

When you need to hold parts securely in place and minimize accidental slippage, be sure to mount holding assemblies so that their pole pieces are at right angles to the strongest force acting on the workpiece. In most cases, the main force will probably be gravity. So the pole pieces should be mounted parallel to the ground, as in Illustration A. Illustration B is the incorrect mounting method.

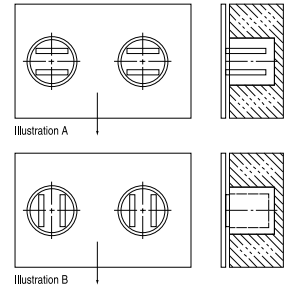

The arrow indicates the pull of gravity.

To make part removal easier, mount the assemblies with their pole pieces parallel to the direction of release motion. This orientation facilitates part movement and removal.

CYLINDRICAL ASSEMBLIES TWO-POLE CERAMIC ASSEMBLIES Standard Model

Part No.	D	L	Holding Value (lbs)
BM1900 x 1/2	1/4	1/2	0.4
BM1900 x 3/4	1/4	3/4	0.5
BM1902 x 1/2	3/8	1/2	1.0
BM1902 x 3/4	3/8	3/4	2.0
BM1902 x 1	3/8	1	2.5
BM1904 x 1/2	1/2	1/2	3.0
BM1904 x 3/4	1/2	3/4	4.0
BM1904 x 1	1/2	1	5.0

- All dimensions are in inches.
- Holding values calculated for optimum conditions.
- Specifications subject to change without notice.

Tapped Model

Part No.	D	L	Tap Size (unc)	Depth	Holding Value (lbs)
BM1906T x 1/2	5/8	1/2	#8-32	3/16	3.0
BM1906T x 3/4	5/8	3/4	#8-32	3/16	7.0
BM1906T x 1	5/8	1	#8-32	3/16	8.0
BM1908T x 1/2	3/4	1/2	#10-32	3/16	4.0
BM1908T x 3/4	3/4	3/4	#10-32	3/16	12.0
BM1908T x 1	3/4	1	#10-32	3/16	17.0
BM1908T x 1 1/4	3/4	1 1/4	#10-32	3/16	20.0
BM1912T x 1/2	1	1/2	#1/4-20	3/16	8.0
BM1912T x 3/4	1	3/4	#1/4-20	3/16	15.0
BM1912T x 1	1	1	#1/4-20	1/4	23.0
BM1912T x 1 1/4	1	1 1/4	#1/4-20	1/4	28.0
BM1912T x 1 1/2	1	1 1/2	#1/4-20	1/4	32.0
BM1914T x 1/2	1 1/4	1/2	#1/4-20	3/16	10.0
BM1914T x 3/4	1 1/4	3/4	#1/4-20	3/16	24.0
BM1914T x 1	1 1/4	1	#1/4-20	1/4	32.0
BM1914T x 1 1/4	1 1/4	1 1/4	#1/4-20	1/4	40.0
BM1914T x 1 1/2	1 1/4	1 1/2	#1/4-20	1/4	48.0

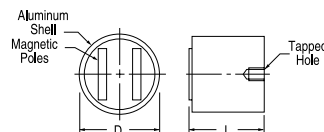
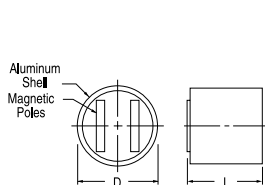

• Dimensional Tolerances:

D - ± .005"

L - ± .015"

Permanent Magnetic Holding Assemblies

Alnico, Ceramic, and Rare Earth

Tapped Model

Part No.	D	L	Tap Size (unc)	Tap Depth	Holding Value (lbs)
BM1936T x 1/2	5/8	1/2	#8-32	3/16	8.0
BM1936T x 3/4	5/8	3/4	#8-32	3/16	13.0
BM1936T x 1	5/8	1	#8-32	3/16	14.0
BM1938T x 1/2	3/4	1/2	#10-32	3/16	10.0
BM1938T x 3/4	3/4	3/4	#10-32	3/16	18.0
BM1938T x 1	3/4	1	#10-32	3/16	23.0
BM1938T x 1 1/4	3/4	1 1/4	#10-32	3/16	24.0
BM1940T x 1/2	1	1/2	#1/4-20	3/16	10.0
BM1940T x 3/4	1	3/4	#1/4-20	3/16	32.0
BM1940T x 1	1	1	#1/4-20	1/4	42.0
BM1940T x 1 1/4	1	1 1/4	#1/4-20	1/4	43.0
BM1940T x 1 1/2	1	1 1/2	#1/4-20	1/4	45.0
BM1942T x 1/2	1 1/4	1/2	#1/4-20	3/16	11.0
BM1942T x 3/4	1 1/4	3/4	#1/4-20	3/16	40.0
BM1942T x 1	1 1/4	1	#1/4-20	1/4	54.0
BM1942T x 1 1/4	1 1/4	1 1/4	#1/4-20	1/4	64.0
BM1942T x 1 1/2	1 1/4	1 1/2	#1/4-20	1/4	68.0

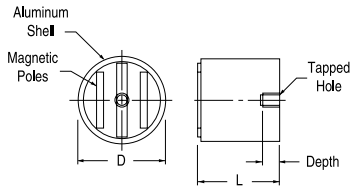

Thru-Hole Model

Part No.	D	L	Screw Size (unc)	Holding Value (lbs)
BM1938H x 1/2	3/4	1/2	#6-32	9.0
BM1938H x 3/4	3/4	3/4	#6-32	15.0
BM1938H x 1	3/4	1	#6-32	17.0
BM1938H x 1 1/4	3/4	1 1/4	#6-32	19.0
BM1940H x 1/2	1	1/2	#8-32	10.0
BM1940H x 3/4	1	3/4	#8-32	27.0
BM1940H x 1	1	1	#8-32	30.0
BM1940H x 1 1/4	1	1 1/4	#8-32	33.0
BM1940H x 1 1/2	1	1 1/2	#8-32	34.0
BM1942H x 1/2	1 1/4	1/2	#10-32	10.0
BM1942H x 3/4	1 1/4	3/4	#10-32	33.0
BM1942H x 1	1 1/4	1	#10-32	50.0
BM1942H x 1 1/4	1 1/4	1 1/4	#10-32	61.0
BM1942H x 1 1/2	1 1/4	1 1/2	#10-32	66.0

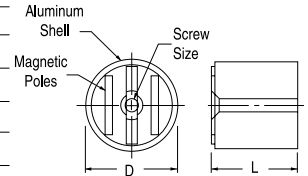

Rare Earth Assemblies

Concentric Neo Assemblies

Part No.	D	T	Tap Size	Tap Depth	Wt. (lbs)	Holding Value (lbs)
BM2101RE	3/8	1/2	#8-32	0.28	.013	5.3
BM2102RE	1/2	1/2	#10-32	0.28	.024	14.0
BM2103RE	5/8	1/2	#10-32	0.28	.040	23.0
BM2104RE	3/4	1/2	#10-32	0.28	.058	36.0
BM2105RE	1	1/2	#1/4-20	0.28	.102	58.0
BM2106RE	1 1/4	1/2	#5/16-18	0.34	.163	100.0
BM2107RE	1 3/8	1/2	#5/16-18	0.28	.194	115.0

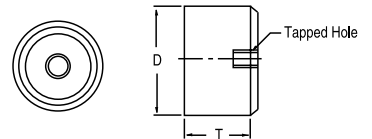

Rare Earth Assemblies Two- and Three-Pole Neo Assemblies

Part No.	D	T	# of Poles	Wt. (lbs)	Holding Value (lbs)
BM2021RE	1/4	1/2	2	.003	2.0
BM2022RE	3/8	1/2	2	.006	5.5
BM2023RE	1/2	1/2	2	.011	10.4
BM2031RE	5/8	1/2	3	.021	19.3
BM2032RE	3/4	1/2	3	.031	34.6
BM2033RE	1	1/2	3	.056	55.5
BM2034RE	1 1/4	1/2	3	.089	85.0

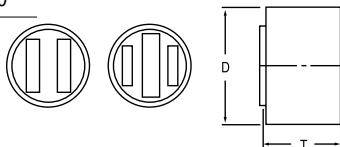

- All dimensions are in inches.
- Holding values calculated for optimum conditions.
- Specifications subject to change without notice.

• Dimensional Tolerances:

D - ± .005"
L - ± .015"

Permanent Magnetic Holding Assemblies

Alnico, Ceramic, and Rare Earth



Rare Earth Assemblies

Part No.	D	L	Tap Size (unc)	Tap Depth	Holding Value (lbs)
BM2004	1/2	15/32	#10-32	13/64	6.0
BM2006	5/8	5/8	#1/4-20	13/64	14.0
BM2010	7/8	13/16	#1/4-20	15/64	29.0
BM2012	1	1	#1/4-20	15/64	33.0

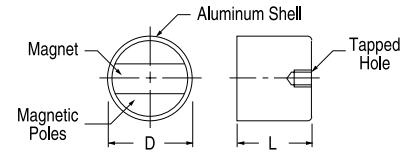

Alnico Assemblies

Part No.	D	L	Tap Size (unc)	Tap Depth	Holding Value (lbs)
BM1070 x 1/2	1/4	1/2	#6-32	1/8	0.5
BM1071 x 1/2	3/8	1/2	#6-32	1/8	0.7
BM1071 x 3/4	3/8	3/4	#6-32	1/8	1.0
BM1071 x 1	3/8	1	#6-32	1/8	1.3
BM1072 x 1/2	1/2	1/2	#6-32	1/8	1.9
BM1072 x 3/4	1/2	3/4	#6-32	1/8	2.3
BM1072 x 1	1/2	1	#6-32	1/8	2.7
BM1073 x 1/2	5/8	1/2	#8-32	1/8	4.2
BM1073 x 1	5/8	1	#8-32	1/8	6.0
BM1074 x 3/4	3/4	3/4	#8-32	1/8	9.0
BM1074 x 1	3/4	1	#8-32	1/8	11.0
BM1076 x 1/2	1	1/2	#10-32	1/8	11.0
BM1076 x 3/4	1	3/4	#10-32	1/8	19.0

Part No.	D	L	Tap Size (unc)	Tap Depth	Holding Value (lbs)
BM1076 x 1	1	1	#10-32	1/8	25.0
BM1077 x 3/4	1 1/4	3/4	#1/4-20	1/4	21.0
BM1077 x 1	1 1/4	1	#1/4-20	1/4	26.0
BM1077 x 1 1/4	1 1/4	1 1/4	#1/4-20	1/4	32.0
CO1452	1 1/4	1 25/64	#10-32	3/16	36.0

Part No.	D (mm)	L (mm)	Tap Size (mm)	Tap Depth	Holding Value (lbs)
BM1063	17.5	16.0	M6	4.0	5.0
BM1065	20.6	19.0	M6	4.8	8.0

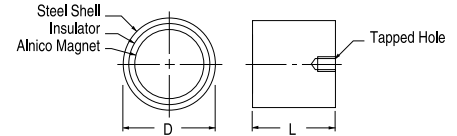

SHALLOW CYLINDRICAL ASSEMBLIES

Shallow Ceramic

Part No.	D	L	Tap Size (unc)	Tap Depth	Holding Value (lbs)
BM2952T	7/8	7/16	#8-32	3/8	1.5
BM2953T	1 1/4	3/8	#10-32	5/16	5.0
BM2955T	1 7/8	3/8	#5/16-18	5/16	12.0

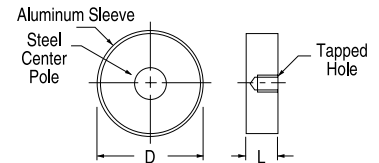

Shallow Pot Alnico Assemblies

Part No.	A	B	D	L	Holding Value (lbs)
BM1054	17/64	9/64	3/4	5/16	8.0
BM1057	11/32	3/16	1 1/8	11/32	11.0
BM1059	11/32	3/16	1 1/2	27/64	29.0

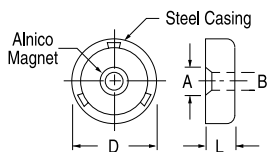

Shallow Pot Ceramic Assemblies

Part No.	D	L	Holding Value (lbs)
BM1802	1 13/16	27/64	13.2
BM1806	2 19/32	27/64	55.1

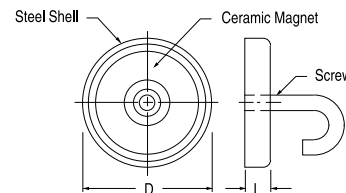

- All dimensions are in inches.
- Holding values calculated for optimum conditions.
- Specifications subject to change without notice.

• Dimensional Tolerances:
D - ± .005"
L - ± .015"

Permanent Magnetic Holding Assemblies

Alnico, Ceramic, and Rare Earth

CHANNEL-TYPE MAGNETIC ASSEMBLIES

Ceramic Channel-Type Magnets

Part No.	T	Holding Value (lbs)
BM4971	$\frac{3}{8}$	50
BM4974	$\frac{9}{16}$	80

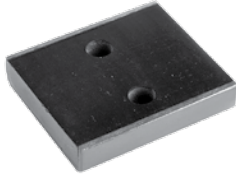
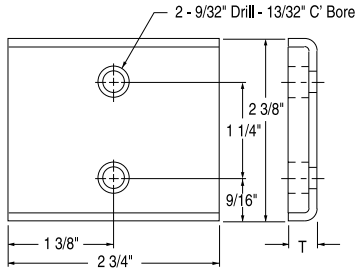

Ceramic Channel-Type Magnets

Part No.	T	Holding Value (lbs)
BM4902	$\frac{3}{8}$	25
BM4904	$\frac{9}{16}$	34

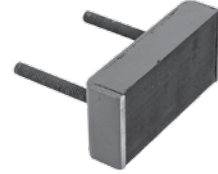
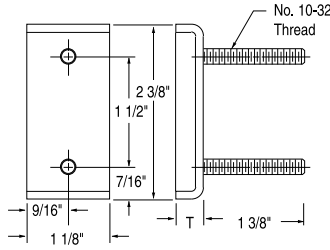

Ceramic Channel-Type Magnets

Part No.	T	Holding Value (lbs)
BM4979	$\frac{3}{8}$	23
BM4981	$\frac{1}{2}$	52
BM4982	$\frac{9}{16}$	57

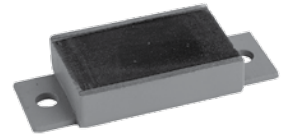
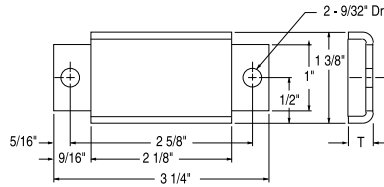

Ceramic Channel-Type Magnets

Part No.	T	Holding Value (lbs)
BM4975	$\frac{3}{8}$	20
BM4978	$\frac{9}{16}$	34

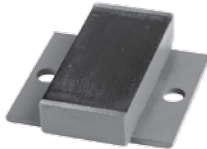
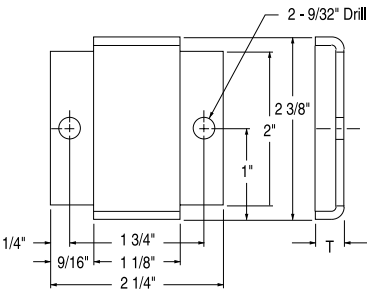

Ceramic Channel-Type Magnets

Part No.	W	$\frac{W}{2}$	L*	Holding Value (lbs)**
BM4919 - 12	$2 \frac{3}{8}$	$1 \frac{3}{16}$	12	40
BM4919 - 24	$2 \frac{3}{8}$	$1 \frac{3}{16}$	24	40
BM4919 - 36	$2 \frac{3}{8}$	$1 \frac{3}{16}$	36	40
BM4919 - 48	$2 \frac{3}{8}$	$1 \frac{3}{16}$	48	40
BM4921 - 12	$\frac{3}{4}$	$\frac{3}{8}$	12	11
BM4921 - 24	$\frac{3}{4}$	$\frac{3}{8}$	24	11
BM4921 - 36	$\frac{3}{4}$	$\frac{3}{8}$	36	11
BM4921 - 48	$\frac{3}{4}$	$\frac{3}{8}$	48	11
BM4923 - 12	1	$\frac{1}{2}$	12	19
BM4923 - 24	1	$\frac{1}{2}$	24	19
BM4923 - 36	1	$\frac{1}{2}$	36	19
BM4923 - 48	1	$\frac{1}{2}$	48	19
BM4929 - 12	$1 \frac{3}{8}$	$\frac{11}{16}$	12	32
BM4929 - 18	$1 \frac{3}{8}$	$\frac{11}{16}$	18	32
BM4929 - 24	$1 \frac{3}{8}$	$\frac{11}{16}$	24	32
BM4929 - 36	$1 \frac{3}{8}$	$\frac{11}{16}$	36	32
BM4929 - 48	$1 \frac{3}{8}$	$\frac{11}{16}$	48	32



Ceramic Channel-Type Magnets

Part No.	T	Holding Value (lbs)
BM4983	$\frac{3}{8}$	35
BM4986	$\frac{9}{16}$	108

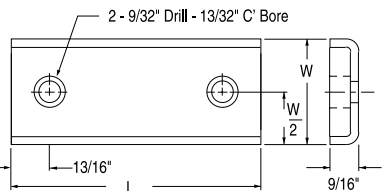
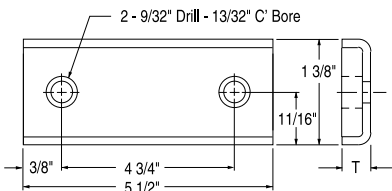

* Other lengths available in $\frac{1}{2}$ " increments. We recommend that channel length not exceed 4 feet.

** Per inch of channel length.

*** 36" x 48" lengths have center mounting hole.

Permanent Magnetic Holding Assemblies

Alnico, Ceramic, and Rare Earth



RECTANGULAR ASSEMBLIES

Rectangular Two-Pole Ceramic Assemblies

Part No.	A	Holding Value (lbs)
BM3965	$7/16$	80
BM3966	$11/16$	120
BM3967	$29/32$	160

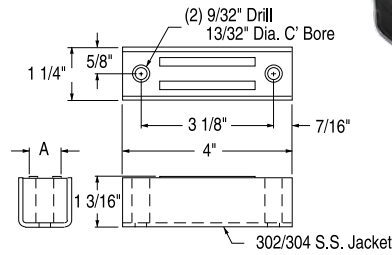

SCREW-RELEASE HOLDFASTS

Ceramic Shallow Holdfasts

Part No.	D	L	Holding Value (lbs)
BM1808	$2 \frac{19}{32}$	$27/64$	55
BM1810	$2 \frac{61}{64}$	$33/64$	77
BM1812	$3 \frac{15}{16}$	$5/8$	165

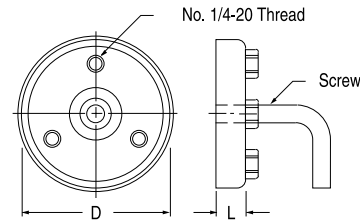

Rectangular Three-Pole Ceramic Assemblies

Part No.	A	Holding Value (lbs)
BM3968	$1 \frac{1}{4}$	200
BM3969	$1 \frac{7}{8}$	250

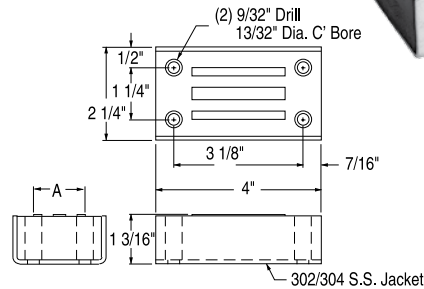

Alnico Holdfasts

Part No.	D	L	Holding Value (lbs)
BM1040	$1 \frac{3}{4}$	$1 \frac{3}{4}$	73
BM1044	$2 \frac{3}{4}$	$2 \frac{1}{2}$	287

Note: Max temp is 212° F

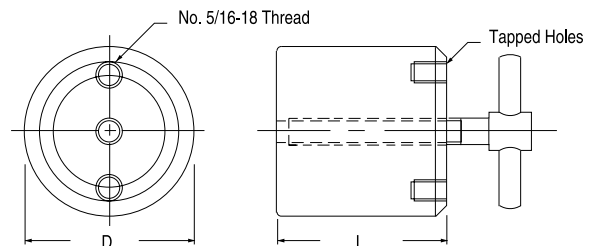

Custom and Modified Permanent Magnetic Assemblies

Custom assemblies are sometimes required for unusual installations or demanding environments, such as watertight, high-temperature, and other specialized applications. For increased holding power, many standard Magnetic Holding Assemblies can be ordered with Rare Earth magnet material as the energy source. We'll manufacture to your specifications and even help you determine what those specifications should be.

- All dimensions are in inches.
- Holding values calculated for optimum conditions.
- Specifications subject to change without notice.

VAUEMAG™ Magnetic Holding Assemblies

Utility-Grade Assemblies for Mass Market Applications

BN6 Countersunk Assembly - Zinc Plating

Part No.	OD	ID	T	Screw Size	Holding Force (lbs)
BN6-16	0.630	0.137	0.177	#4	16.8
BN6-20	0.787	0.177	0.236	#6	23.6
BN6-25	0.985	0.177	0.275	#6	35.9
BN6-32	1.260	0.216	0.275	#8	69.7

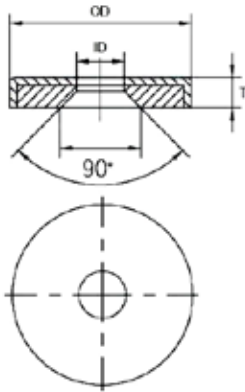

BNA Countersunk Assembly - Zinc Plating

Part No.	OD	ID	T	Screw Size	Holding Force (lbs)
BNA-16	0.630	0.137	0.250	#4	11.0
BNA-20	0.787	0.177	0.283	#6	13.0
BNA-25	0.984	0.216	0.303	#8	30.7
BNA-32	1.260	0.216	0.307	#8	55.0
BNA-36	1.417	0.256	0.300	#9	63.8
BNA-42	1.654	0.256	0.346	#10	81.3
BNA-48	1.890	0.335	0.425	#11	149.7
BNA-60	2.362	0.335	0.590	#12	246.6
BNA-75	2.953	0.413	0.700	#14	356.7

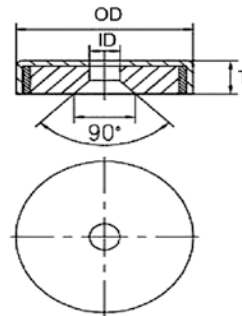

BT Series Ceramic with Zinc Plating

Part No.	D	d	L	H	Tap Size (MG)	Holding Force (lbs)
BT16	0.63	0.24	0.45	0.18	M3	4.0
BT20	0.79	0.24	0.51	0.24	M3	6.7
BT25	0.98	0.31	0.59	0.28	M4	9.0
BT32	1.26	0.31	0.59	0.28	M4	18.0
BT36	1.42	0.31	0.63	0.30	M4	22.5
BT40	1.57	0.31	0.65	0.31	M4	28.1
BT47	1.85	0.31	0.67	0.35	M4	40.5
BT50	1.97	0.31	0.73	0.39	M4	49.5
BT57	2.24	0.31	0.73	0.41	M4	62.9
BT63	2.48	0.59	1.18	0.55	M8	78.7
BT80	3.15	0.79	1.34	0.71	M10	134.9
BT100	3.94	0.87	1.69	0.87	M12	202.3

Also available painted in various colors and with hooks.

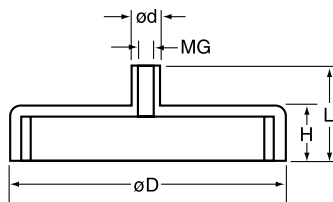

ValueMAG™ Magnetic Holding Assemblies

Utility-Grade Assemblies for Mass Market Applications



BCH Series Ceramic Channel Magnets with Zinc Plating

Part No.	L	W	H	I	Holding Force (lbs)
TS-3**	2.75	1.19	0.50	0.19	35.0
BCH35	3.00	1.50	0.46	0.23	45.0
BCH6	6.00	1.50	0.46	0.23	90.0
BCH8	8.00	1.50	0.46	0.23	120.0
BCH12	12.00	1.50	0.46	0.23	180.0

** TS-3 is Cadmium Plated
Holes in BCH Series are .200" x .275"

*Per 1 inch length.

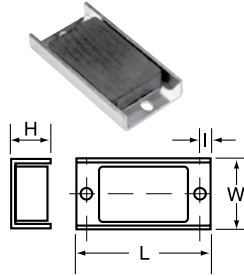

BRB Series Ceramic with Chrome Plating

Part No.	D	H	d	ID	Holding Force (lbs)
BRB20	1.21	0.19	0.13	.200	2.9
BRB40	1.43	0.27	0.19	.375	11.9
BRB50	2.04	0.30	0.19	.850	24.7
BRB60	2.39	0.35	0.27	1.000	40.5
BRB70	2.68	0.38	0.28	.990	65.2
BRB75	2.81	0.37	0.27	.975	67.4
BRB80	3.20	0.42	0.28	1.200	95.5
BRB85	3.87	0.51	0.38	1.750	110.2
BRB90	4.88	0.49	0.50	2.600	179.8

Optional Nickel or Zinc Plated or Black Polyester Powder.

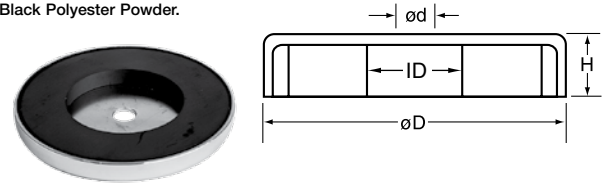

BA Series Alnico with Threaded Hole, Brass Ring, Zinc Plating

Part No.	D	H	Tap Size (MG)	Holding Force (lbs)
BA6	0.24	0.79	M3X5	0.3
BA8	0.31	0.79	M3X5	0.8
BA10	0.39	0.79	M4X7	1.6
BA13	0.51	0.79	M4X7	2.2
BA16	0.63	0.79	M4X5	4.0
BA20	0.79	0.98	M6X7	9.4
BA25	0.98	1.38	M6X9	21.6
BA27	1.06	0.98	M6	14.6
BA32	1.26	1.57	M8X9	40.5
BA35	1.38	1.18	M6	31.9

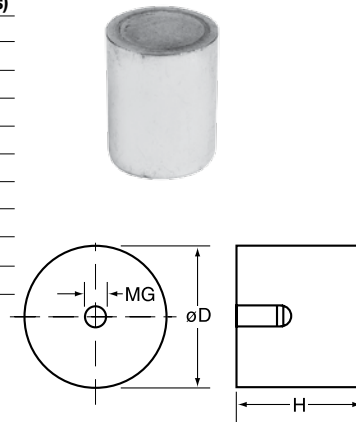

BTN Series Rare Earth Neodymium with Zinc Plating

Part No.	D	d	L	H	Tap Size (MG)	Holding Force (lbs)
BTN6	0.24	0.24	0.45	0.18	M3	1.1
BTN8	0.31	0.24	0.45	0.18	M3	2.9
BTN10	0.39	0.24	0.45	0.18	M3	5.6
BTN13	0.51	0.24	0.45	0.18	M3	13.5
BTN16	0.63	0.24	0.45	0.18	M4	21.4
BTN20	0.79	0.31	0.51	0.24	M4	31.5
BTN25	0.98	0.31	0.55	0.28	M4	45.0
BTN32	1.26	0.39	0.61	0.28	M5	78.7

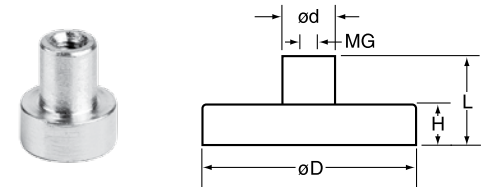

* All measurements are in inches.

- Unless otherwise specified, magnets will be furnished in magnetized condition.
- Holding forces are approximate. These are average values obtained under laboratory conditions. Size, shape, and material of the test piece may affect actual pull forces.

BT & BTN Series Hooks

Part No.	Thread Size
M3-Hook	M3
M4-Hook	M4
M5-Hook	M5
M8-Hook	M8
M10-Hook	M10
M12-Hook	M12



VAUEMAG™ Magnetic Holding Assemblies

Utility-Grade Assemblies for Mass Market Applications

BMT Series

Part No.	D	H	Holding Force (lbs)
----------	---	---	---------------------

BMT135	3.15	.472	65.0
--------	------	------	------

For use with threaded broom handle



Part No.	D	H	Holding Force (lbs)
----------	---	---	---------------------

BMT253	2.56	.394	25.0
--------	------	------	------

Ideal for pictures, calendars, and banners



Part No.	D	H	Holding Force (lbs)
----------	---	---	---------------------

BMT175	3.15	.472	65.0
--------	------	------	------

Can hold up to a 1" hose size



Part No.	D	H	Holding Force (lbs)
----------	---	---	---------------------

BMT252	2.56	.394	25.0
--------	------	------	------

Great for holding drawings and prints



Part No.	D	H	Holding Force (lbs)
----------	---	---	---------------------

BMT254	1.42	.275	5.0
--------	------	------	-----

Workstation papers and pad holder



Magnetic Tool Holder

Hard plastic with sandwich magnets provide excellent holding power.

Part No.	W	L	T
----------	---	---	---

BMT301	1.57	13.8	.98
--------	------	------	-----



Magnetic Pull Test Kit

The Bunting® Magnetic Test Kit has been developed for the purpose of field inspection, measurement and performance analysis of permanent magnetic separation equipment to guard against a lapse in magnetic protection. Field tests on magnetic equipment are most accurately done by measuring the relative magnetic attraction of a separator on a ferrous test piece.

This test kit includes test pieces and tools which have been selected to offer maximum flexibility for testing a broad range of magnetic separator styles. As with any analytical procedure, consistency and repeatability are key to producing usable test data.

Part No. - PTK 2000



VaueMAG™ Magnetic Separation Products

Utility-Grade Products for Mass Market Applications



For Food Grade products, call our corporate office at (800) 835-2526

Magnetic Cartridges/Magnetic Tubes

Part Length	Ceramic Part No.	NPB Part No.	NHI Part No.
4	C4004CR	C4004NPB	C4004NHI
6	C4006CR	C4006NPB	C4006NHI
8	C4008CR	C4008NPB	C4008NHI
10	C4010CR	C4010NPB	C4010NHI
12	C4012CR	C4012NPB	C4012NHI
14	C4014CR	C4014NPB	
16	C4016CR	C4016NPB	
18	C4018CR	C4018NPB	
20	C4020CR	C4020NPB	
22	C4022CR	C4022NPB	
24	C4024CR	C4024NPB	



NOTE: All cartridges have a 1" diameter. 1/4" 20 Tap - Both Ends

Drawer Magnet

Ceramic Part No.	Width (inches)	Length (inches)	No. of Cartridges top/bottom
GH-0608-CR	6.125	8.125	3/2
GH-0810-CR	8.125	10.125	4/3
GH-1012-CR	10.125	12.125	5/4

NOTE: All part numbers are 8" in height.

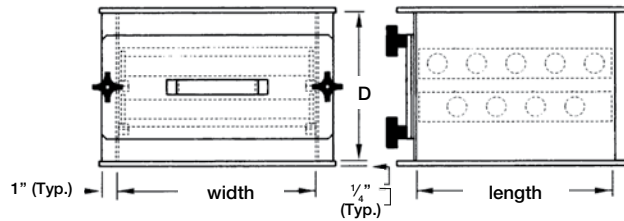

Grate Magnets

Square Ceramic Plain - No Baffle			Square Neo-Power Balanced Plain - No Baffle		
Part No.	Width (inches)	Length (inches)	Part No.	Width (inches)	Length (inches)
GS-4P-CR	4	4	GS-6P-NPB	6	6
GS-6P-CR	6	6	GS-8P-NPB	8	8
GS-8P-CR	8	8	GS-10P-NPB	10	10
GS-10P-CR	10	10	GS-12P-NPB	12	12
GS-12P-CR	12	12	GS-14P-NPB	14	14
GS-14P-CR	14	14			

Rectangular Ceramic Plain - No Baffle			Rectangular Neo-Power Balanced Plain - No Baffle		
Part No.	Width (inches)	Length (inches)	Part No.	Width (inches)	Length (inches)
GS-1006P-CR	10	6	GS-1006P-NPB	10	6
GS-1208P-CR	12	8	GS-1208P-NPB	12	8
GS-1612P-CR	16	12	GS-1612P-NPB	16	12

Round Ceramic Plain - No Baffle			Round Ceramic Angular Baffle		
Part No.	Width (inches)	Length (inches)	Part No.	Width (inches)	Length (inches)
GR-4P-CR	4	4	GR-4A-CR	4	4
GR-6P-CR	6	6	GR-6A-CR	6	6
GR-8P-CR	8	8	GR-8A-CR	8	8
GR-10P-CR	10	10	GR-10A-CR	10	10
GR-12P-CR	12	12	GR-12A-CR	12	12

Square Ceramic Angular Baffle			Round Neo Power Balanced Plain - No Baffle		
Part No.	Width (inches)	Length (inches)	Part No.	Width (inches)	Length (inches)
GS-4A-CR	4	4	GR-6P-NPB	6	6
GS-6A-CR	6	6	GR-8P-NPB	8	8
GS-8A-CR	8	8	GR-10P-NPB	10	10
GS-10A-CR	10	10	GR-12P-NPB	12	12
GS-12A-CR	12	12			

Standard units feature 1" diameter cartridges encased in 316 Stainless steel and mounted on 2" centers

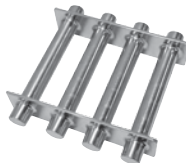
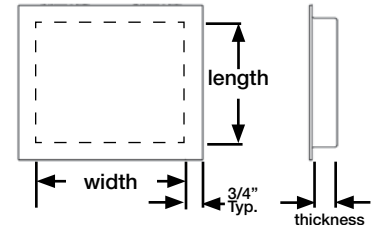
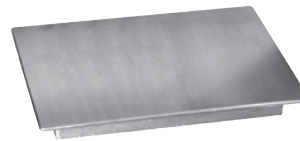

Plate Magnets

Ceramic				Rare Earth			
Part No.	Width (inches)	Length (inches)	Thickness (inches)	Part No.	Width (inches)	Length (inches)	Thickness (inches)
PM-0607-CR	6	7.625	2.00	PM-0605-NPB	6	5.50	1.125
PM-0807-CR	8	7.625	2.00	PM-0805-NPB	8	5.50	1.125
PM-1007-CR	10	7.625	2.00	PM-1005-NPB	10	5.50	1.125
PM-1207-CR	12	7.625	2.00	PM-1205-NPB	12	5.50	1.125
PM-1607-CR	16	7.625	2.00	PM-1405-NPB	14	5.50	1.125
PM-2007-CR	20	7.625	2.00				
PM-2407-CR	24	7.625	2.00				



Sight Glass Magnets

N35SH ND-FE-B Magnet					
Part No.	(A)Ring	(C)Diameter	(D)Handle	(F)Length	
SGM1	1.75	.625	1.875	4.75	
SGM2	2.50	.625	1.875	4.75	
SGM3	1.75	1.00	1.875	6.25	
SGM4	2.50	1.00	1.875	6.25	

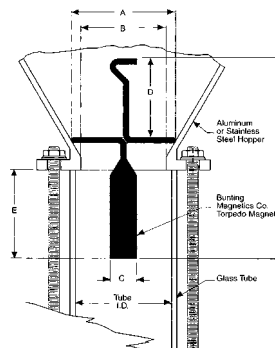

Magnetic Catches and Door Stops

Utility-Grade Assemblies for Mass Market Applications

(All dimensions in Metric)

Door Stops

These door stops can be used for all panels, gates, or doors which must be firmly held in the presence of vibrations, drafts or sudden acceleration.

The body of the door stop is slightly flexible and will compensate to a certain extent for poor fitting. Pole pieces have been treated to resist corrosion. The unit is supplied with the appropriate counter-plate.

Series 1

Wall mounted. The compact magnet is fitted in a flexible neoprene sleeve.

Part No.	Holding Force (kg)	B	E	D	Color
56101	10	16	34	42	Gray
56301	20	22	43	54	Gray
56302	20	22	43	54	Brown
56501	30	30	70	71.3	Gray
56502	30	30	70	71.3	Brown



Series 2

Floor mounted. The compact magnet is housed in a PVC sleeve. For fitting onto a surface which is parallel to the direction of the movement. (e.g. floor)

Part No.	Holding Force (kg)	B	D	E	H	J	Color
56401	20	26	45.5	60	38	50	Gray
56410	10	26	45.5	60	38	50	Gray
56411	20	26	45.5	60	38	50	Brown



Lattam - Lattam magnets consist of ferrite or neodymium magnets bonded onto a metal plate. The magnetic side has several poles (North and South) while the opposite side has no magnetic attraction. Used for any type of attachment, positions, devices, catches, etc. The anti-slip versions provide excellent resistance to slippage.

Bare Lattam

Part No.	Holding Force (kg)	A	B	C
33203	1	25	13.3	3
33204	1.5	25	13.3	4.8
33205	2	42	12	4.6

Material: ferrite magnets bonded onto a metal plate.

Mounting: bonding, over-molding.

Applications: supporting, securing items.

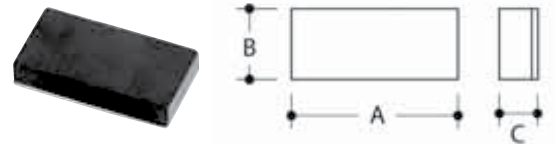

Over-Molded Lattam Magnet

Model	Part No.	Holding Force (kg)	A	B	C
Rectangular	33301	2.4	45	20	6
Rectangular	33303	3.1	60	20	6

Model	Part No.	Holding Force (kg)	Dia.	E
Cylindrical	33104	1.3	25	6
Cylindrical	33105	3	38	11.5

Material: ferrite magnets bonded onto a metal plate; black impact polystyrene over-moulded.

Mounting: can be bonded.

Applications: supporting, securing items.

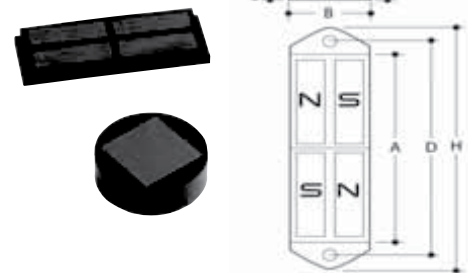

Anti-Slip Lattam Magnet

Part No.	Holding Force (kg)	A	B	C
33505	3.5	60	30	7.5

Note: foamed adhesive may be added (ask us).

Material: ferrite magnets bonded onto a metal plate and over-moulded with an anti-slip elastomer provide high resistance to slippage.

Mounting: can be bonded.

Applications: used to vertically support devices.



Magnetic Catches and Door Stops

Utility-Grade Assemblies for Mass Market Applications



Recessed Catches

These catches are designed for furniture and allow you to obtain an attractive finish on all types of furniture. They are easy to install and are thus ideal for applications with large production runs.

Is Series

These cylindrical magnetic catches are encased in a plastic sleeve. The front surface is round. In a ribbed body, they hold tightly in the given position and a flange ensures accurate positioning.

Part No.	Holding Power (kg)	A	B	E	H	Color
17101	1	.374	.315	.413	.354	Black
17120	2	.374	.315	.591	.543	White
17121	2	.374	.315	.591	.543	Black
17122	2	.374	.315	.591	.543	Brown
17140	4	.551	.433	.602	.551	White
17141	4	.551	.433	.602	.551	Black
17142	4	.551	.433	.602	.551	Brown
17160	6	.630	.531	.720	.670	White
17161	6	.630	.531	.720	.670	Black
17162	6	.630	.531	.720	.670	Brown

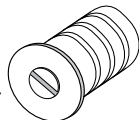
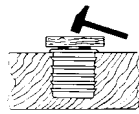

Fixing: Drill a hole for the diameter which is compatible with the hardness of the panel. Sink the magnetic catch by tapping it gently with a mallet or, using a wooden block, with a hammer.

Counterplate: Use a W or Z counterplate of the same or higher number.

Counterplate

The most widely used counterplates, they are round and fitted by one single countersunk screw. The screw head must not protrude beyond the ground front surface. When fitting this counterplate do not screw it fully down. In this case, it can take up a little play.

Series W

Part No.	A	B	D
25451 (Copper)	.472	.098	.098
25412 (Zinc)	.472	.098	.098
55410 (Zinc only)	.591	.118	.126

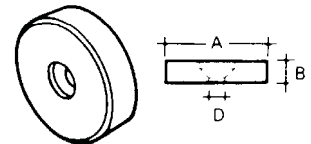

Series Z

Part No.	A	B	C
25351 (Copper)	.472	.098	.453
25312 (Zinc)	.472	.098	.453

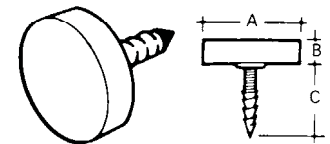

Counterplate These counterplates are zinc plated. They are fitted using 3mm countersunk screws.

Part No.	A	B	C	D	Model
25602	1.57	.55	.059	1.18	C2
25610	2.60	.47	.078	2.13	Q10

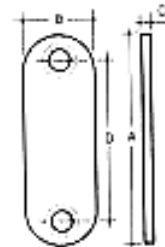

CF Series Recess mounted and Adjustable.

Part No.	Holding Power (kg)	Dia	Length
54237	5	.55	.87

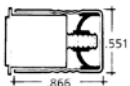

Raly Series Designed for surface mounting on wood or metal. The pole pieces are locked into the plastic body. Two oblong slots allow for adjustment. As the pole pieces are fixed, an appropriate mobile counterplate is supplied.

Part No.	Holding Power (kg)	A	B	C	D	E
11101	3	1.38	.55	.55	.98	.51
11103	5	1.89	.55	.55	1.50	1.00
11104	6	2.20	.55	.55	1.81	1.34

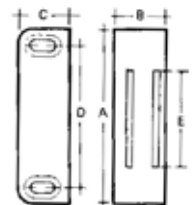

Bs Series Surface-mounted model The attraction force is parallel to the mounting surface.

Part No.	Holding Power (kg)	A	B	C	D	E
20210	4	2.44	.413	.453	2.126	1.83
61210	5	3.23	.580	.725	2.80	2.32

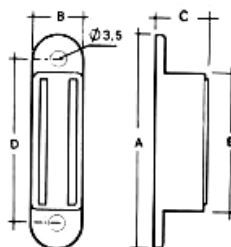

Magnetic Catches and Door Stops

Utility-Grade Assemblies for Mass Market Applications

Magnetic Catches

Over 100 standard models are available in a variety of designs and colors, with holding powers up to 88 pounds. Catches are manufactured in a assortment of materials, with many mounting and adjustment options.

Klip Series

The flexible clip-in lugs form an integral part of the body.

Part No.	Holding Power (kg)	A	B	C	E	F	M
21707 (white)	4.0	1.55	.39	.47	.85	.43	.31
21720 (black)	15.0	2.13	.49	.57	.42	2.03	.43

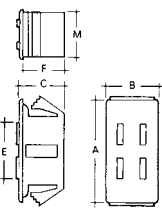
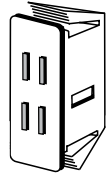

Fixing: These magnets clip in to an opening approximately 2.05". This dimension has to be precisely adjusted by the user according to the thickness of the substrate and the surface condition of the cut-out (burrs flanges, etc.).

Counterplate: For all of these series, use a steel surface which is at least 1.5mm thick; 2mm for the Klip 15. A model Qcounterplate may be used.

Supec A Series

Part No.	Holding Power (kg)	A	B	C	D	E
11310 (white)	4	1.89	.748	.591	1.50	.846
11312 (brown)	4	1.89	.748	.591	1.50	.846

Mounting: Two 3mm screws through oblong slots.

Counterplate: model #25602

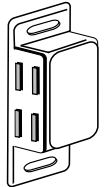
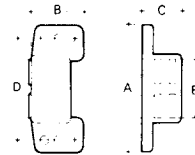

Cs Series

These are for surface mounting. The attraction force is perpendicular to the fixing surface.

Part No.	A	B	D
20306 (Black)	1.77	.413	1.46
20351 (white)	1.77	.413	1.46

Counterplate included

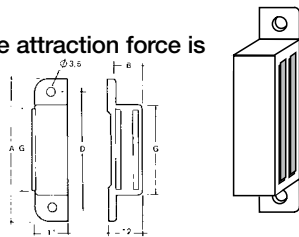

Supec Heavy Duty

Magnetic catches for big doors (cupboards).

Part No.	Holding Power (kg)	A	B	C	D	E
11241 (white)	12	2.91	.689	.551	2.52	1.69
11242 (brown)	12	2.91	.689	.551	2.52	1.69

Mounting: Two 3mm screws through oblong slots.

Counterplate: model #25610

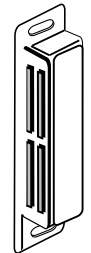
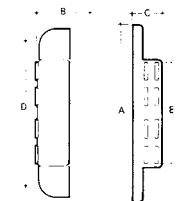

Series F

These have a white impact resistant polystyrene body with an acetal resin spring to act as a shock absorber and keep the pole pieces forward.

Part No.	Holding Power (kg)	A	B	C	E	F	M
21305	4	1.57	.394	.472	.846	.433	.315
21111 (black)	8	2.52	.394	.472	1.69	.512	.315
21510	10	2.52	.413	.453	1.69	.512	.394

Color: Standard white

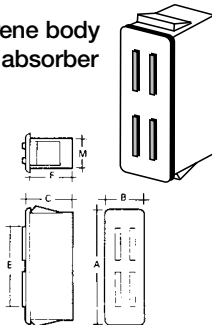

Slimline

This extra flat model is made from a high performance magnetic rubber. The mobile pole pieces are cushioned by a damper for shock absorption and to take up play.

Part No.	Holding Power (kg)
52621 (white)	5 (with plate)
52606 (brown)	5 (without plate)

Fixing: 2.5mm diameter countersunk screw.

It has a lip to prevent it from rotating.

Counterplate: Part No. 55611

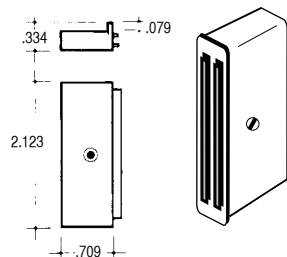

Holding Magnets

Constructed of a magnet embedded in a steel channel, or a magnet sandwiched between two steel plates, these magnets provide strong pull for their sizes. Most come with mounting holes.

Holding power is tested on a flat, machined steel plate, 1/2" thick. If the surface to which the magnet is to be attached is rough, rusty or painted, the holding force may be reduced. For critical applications, build in a safety factor of two or three.

Part No.	Holding Power (lbs)	A	B	C	Hole Dia.
MO-70SV	8	.812	1.00	.312	.187
MO-70V	7	.875	1.00	.250	.125*
MO-80E	6	.937	2.00	.312	.160
MO-81	45	1.00	2.00	.625	.188

*Dimples on steel plates

*Dimples on steel plates

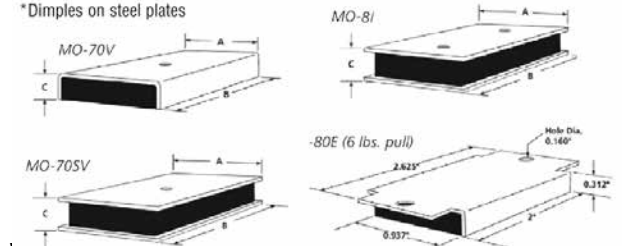

Magnetic Catches and Door Stops

Elite Catches



Surface Mounted

This product line offers surface mounted magnetic catches with all of the magnets and pole pieces hidden from view. These catches do not require direct contact with the counter plate and provide near silent operation. The excellent performance of our catches means that they can help prevent doors from bowing. If the doors do bow slightly, our elite catches will continue to perform unlike a conventional catch.



Part No.'s

Brass	Chrome	Black Nickel	A	B	C
CA268B	CA268C	CA268N	42	11	11
CA256B	CA256C	CA256N	42	17	11
CA257B	CA257C	CA257N	63	17	12

Sizes are in MM

Elite F5

Part No.	A	B	C
CA258B	54	14	12
CA258C	54	14	12
CA258N	54	14	12

Sizes are in MM



Flush Range

These high quality magnetic catches are concealed from view. The assembly is constructed to provide a flush fit to any door or frame. They will hold in the frame of doors securely and quietly. All of these products can be mounted within the woodwork so they are visible or mounted sub-flush so they become totally invisible after filling.

Elite Knock In

Part No.	Holding Force (kg)	D	T
BNMS040KX-M	2	14	11

Sizes are in MM, Sold in Pairs



Elite Tap In

Part No.	Pole	Holding Force (kg)	D	T
BNMS040NX-M	North	2	12	8
BNMS040SX-M	South	2	12	8

Sizes are in MM



Elite Tap In with Spike

Part No.	Holding Force (kg)	D	T
BNMS040AX-M	2	12	19
BNMS049B-M	2	15	22

Sizes are in MM



Elite Drilling Fixture

Part No. MS257A

Sizes are in MM

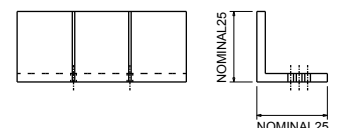
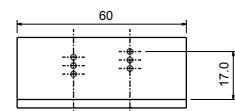

Permanent Magnetic Tools

Get Outstanding Holding Power and Versatility

Grounding Clamps Quick, Safe Grounding for Welding or Static Electricity

Quick Ground

Welders have found Quick Ground to be a great time saver for obtaining fast grounding. Quick Ground is especially useful on tanks, pipe, large ferrous sheets, and work where ground is hard to establish with conventional clamps.



Part No.	Dimensions	Pull (lbs)
MG1	2" x 2 1/2" x 3 1/4"	45

Magnetic Hand Tools The Fast, Easy Way to Handle Sheet Metal and Pick Up Small Parts

Magnetic Sheet Metal Handles

These economical, reliable Metal Handles permit safe and efficient handling of sheet metal and hard-to-handle metal parts. Select the model you need for light to heavy lifting. Bunting Magnetic Handles are ideal for separating oiled sheets, pulling sheets from racks, and positioning sheets for welding. Just lower the handle for quick release.

Part No.	Maximum Lift	Maximum Penetration	Wt. (lbs)	Size
MH100	100	1/16"	3.5	3 1/2" x 5"
MH250	250	1/8"	5.0	5 1/4" x 6"
MH400	400	1/8"	7.5	5 1/2" x 6"
MH600	600	1/8"	9.5	6" x 7 1/2"



Magnetic Pickup Tools

These handy tools are scientifically designed for fast, efficient pickup of small parts. Touch the bottom of the Magnetic Pickup to the parts to capture and hold them in place. To drop them, simply pull up the center handle and parts are released. Three models are available with lifting capacities of 2-3 lbs (Model 71-30), 4-5 lbs (Model 72-30), and 8-9 lbs (Model 74-30). All have rugged, dirt-proof construction and plastic cases.

Part No.	Dimensions	Part No.	Dimensions
Model-71	5" x 1 3/4" x 9"	Model-71-30	5" x 1 3/4" x 30"
Model-72	5" x 3 3/8" x 9"	Model-72-30	5" x 3 3/8" x 30"
Model-74	5" x 6 1/4" x 9"	Model-74-30	5" x 6 1/4" x 30"



Press Feeders

Get lightweight construction, split-second release, low clearance. These permanent Neodymium Rare Earth magnets, feature positive pickup and fast release. The MH1 is a single head press feeder with 8 lbs. of pull force. The MH2 is a two head press feeder with 16 lbs. of pull force. Lightweight, they reduce work fatigue, increase worker efficiency, and reduce time lost from accidents.

Part No.	Head Diameter	Length	Pull Force (lbs)
MH-1	1-1"D	11"	8
MH-2	2-1"D	13"	16



Pull force is based on the size and thickness of the sheets at the point of contact with the magnet.

Pocket Magnet

The Pocket Tool gets its holding power from a high-energy neodymium magnet. The brightly polished, lightweight aluminum shaft has an easy-to-grip knurled handle. Ideal for tradesmen, sportsmen, and hobbyists. Shipping weight is 8 lbs per 100 units.

Part No.	Length	Pull Force
PM101	5 1/2"	2 lbs.



Clean-Out Tools

Our magnetic Clean-Out Tool retrieves ferrous metal objects in dip tanks, plating tanks, heat bake ovens, or oil reservoirs. Its Alnico 5 magnet is attached to a 48" wood handle.

Part No.	Gross Wt. (lbs)	Lift Wt. (lbs)
MS2	3	10
MS4	3	30
MS6	4	45

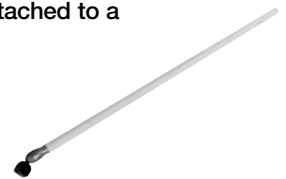

Flexible Magnet

Here's a handy item for the tool kits of mechanics, machinists, and repairmen. This 24" long Flexible Shaft Neodymium Magnet tool is a big time saver in picking up small parts that have fallen into inaccessible places.

Part No.	Length	Pull Force
FM102	24"	4 lbs.



Polarity Indicator

This magnetic pole tester provides an instant zero-delay magnetic pole indication. Press the push-button to activate and the tester will indicate the appropriate magnetic pole via LEDs at once.



Part No. PD251

Electromagnets and Power Supplies

Handle Ferrous Materials Safely and Securely with Bunting® Electromagnets

Round Lifting Magnets are intended to lift solid, compact material. Standard units are not intended for handling scrap or small parts.

Note: Lifting capacities shown are for low-carbon steel at magnetic saturation with a surface finish equivalent to cold-rolled steel. All ratings include a 2:1 safety factor. Do not exceed rated capacity.

Round Lifting Electromagnets

Part No.	Volts	DC Watts	Lift Capacity	A	B	C	Wt. (lbs)
BLE-6030-110	110	85	1000 lbs	3	6	6	25
BLE-8041-110	110	130	2000 lbs	4 1/8	8	7 3/8	48
BLE-10043-110	110	170	3000 lbs	4 3/8	10	8 3/8	86
BLE-12052-110	110	200	4500 lbs	5 1/4	12	9 1/4	146
BLE-16067-110	110	310	8000 lbs	6 3/4	16	12 3/4	360
BLE-20071-110	110	570	12000 lbs	7 1/8	20	14	540

All dimensions are in inches. Models available with or without rectifiers.

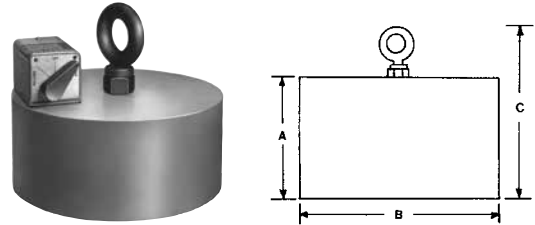

Round Lifting Magnet shown with optional mounted BPS4-0300-110.

Bi-Polar Magnets are best for handling rounded, irregular shaped surfaces – where the magnet may only come in partial contact with the part. Equipped with two lifting surfaces (or poles) spaced apart for maximum power, Bi-Polar Electromagnets provide superior magnetic reach out. This makes the Bi-Polar ideal when air gaps or any nonferrous material comes between the magnet and the product being handled.

Small Bi-Polar Electromagnets

Part No.	Width		Length		Height	MNT'G	Thread & Length		Location of Leads		DC Volts	Watts	Pull* (lbs)	Wt.
	A	B	C	D			E	F	G					
BBP-0916-12	15/16	1 5/8	1 5/8	7/8	10-32 x 15/16	7/16	1/4	12	5.0	25	8 oz			
BBP-1620-12	1 11/16	2	1 13/16	7/8	10-32 x 15/16	1	5/16	12	6.5	80	1 lb			
BBP-1535-12	1 1/2	3 1/2	2 5/8	2 1/4	1/4-20 x 1/2 deep	3/4	5/8	12	12.0	360	2 lbs			
BBP-2341-12	2 3/8	4 1/8	3 7/8	2 1/2	3/8-16 x 1/2 deep	1 3/16	1 1/8	12	15.0	440	6 lbs			
BBP-2856-12	2 7/8	5 5/8	4	3 1/2	3/8-16 x 1/2 deep	1 7/16	1 1/8	12	22.0	650	11 lbs			
BBP-4176-12	4 1/8	7 5/8	4 3/4	5	1/2-13 x 1 deep	2 1/16	1 1/8	12	35.0	1100	25 lbs			

All dimensions are in inches. 100% Duty Cycle.

* For lift capacity, reduce Pull by 50%.

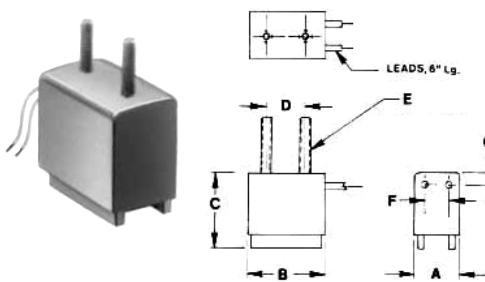

Drawing applies to BBP-0916-12 and BBP-1620-12

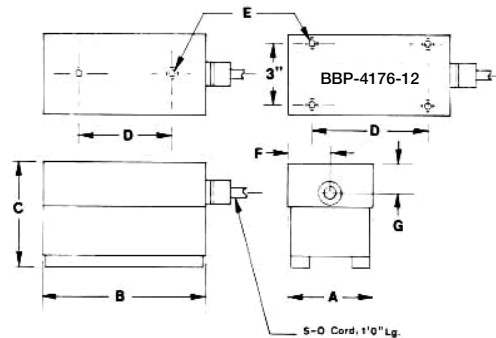

Drawing applies to BBP-1535-12, BBP-2341-12, BBP-2856-12 and BBP-4176-12

Electromagnets and Power Supplies

Handle Ferrous Materials Safely and Securely with Bunting® Electromagnets

Electromagnets provide an efficient and economical solution for handling and holding parts. Available in a number of shapes and sizes, Bunting® Electromagnets require little maintenance and can be used in a variety of manual and automated applications. (Special sizes upon request)

Choose the Electromagnet for Your Application

Flat-Faced Magnets are ideal for maximum holding force on flat, smooth, dry, unpainted surfaces – where the entire face of the magnet comes in direct contact with the product being handled. Designed with a center magnetic pole and utilizing the outer case as the opposite pole, Flat-Faced Electromagnets concentrate the magnetic force at the center of the magnet for superior holding power.

Selecting the Right Electromagnet

There are many factors to be considered when selecting the proper electromagnet, and finding the right one is essential to gaining long-term, valuable use from it.

Bunting® Sales Representatives are available to help you select the appropriate electromagnet. Please feel free to send or fax sketches, drawings, photographs, and any other information that you feel might help us determine what's right for your application. Call today.

Round Electromagnets

(Available in 24 VDC and 110 VDC at no additional charge)

Part No.	Diameter		Thread	Thread Location		DC Volts	Watts	Pull* (lbs)	Wt. (lbs)
	A	B		Depth	of Leads				
BDE-0515-12	0.50	1.500	6-32	3/8	3/16*	12	1.4	4	1.50 oz
BDE-0812-12	0.75	1.250	10-32	3/8	3/16	12	1.5	10	1.70 oz
BDE-1012-12	1.00	1.250	10-32	3/8	3/16	12	4.5	20	2.60 oz
BDE-1007-12	1.00	0.719	10-32	3/8	1/8	12	1.0	10	1.90 oz
BDE-1212-12	1.25	1.250	1/4-20	3/8	1/4	12	3.5	40	4.20 oz
BDE-1716-12	1.75	1.625	1/4-20	1/2	3/8	12	3.0	160	11.00 oz
BDE-2016-12	2.00	1.625	1/4-20	1/2	1/4	12	5.2	220	1.00 lb
BDE-3020-12	3.00	2.000	(2) 1/4-20	1/2	5/8	12	12.0	500	3.25 lbs
BDE-3515-12	3.50	1.500	(2) 1/2-20	1/2	3/16*	12	8.0	650	3.25 lbs
BDE-4032-12	4.00	3.000	(2) 3/8-16	5/8	3/8*	12	33.0	900	9.00 lbs
BDE-6012-12	6.00	1.250	(2) 1/4-20	5/8	7/8*	12	7.8	1000	8.00 lbs

All dimensions are in inches. 100% Duty Cycle.

* For lift capacity, reduce Pull by 50%.

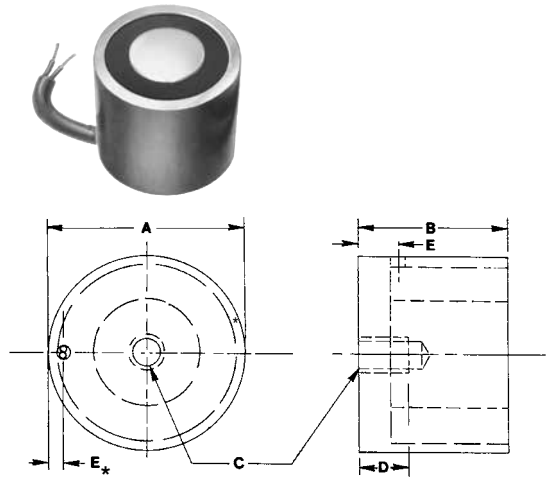

Rectangular Electromagnets

(Available in 24 VDC and 110 VDC at no additional charge)

Part No.	Width		Height	MNT'G		Thread	Thread Depth	Location of Leads		DC Volts	Watts	Pull* (lbs)	Wt. (lbs)
	A	B		D	E			F	G				
BRE-1525-12	1 1/2	2 1/2	1 1/4	1	10-32	3/8	3/4	1/2	12	5	200	1	
BRE-2525-12	2 1/2	2 1/2	1 1/2	3/4	1/4-20	1/2	1 3/4*	3/8*	12	8	450	2	
BRE-2545-12	2 1/2	4 1/2	2	2	1/4-20	1/2	1 1/2	3/4	12	12	750	5	
BRE-3060-12	3	6	2	3	3/8-16	1/2	1+	1+	12	37	1000	11	
BRE-4080-110	4	8	2 1/2	4	3/8-16	3/4	1 1/4+	1 1/4+	110	42	2000	22	

All dimensions are in inches. 100% Duty Cycle.

* For lift capacity, reduce Pull by 50%.

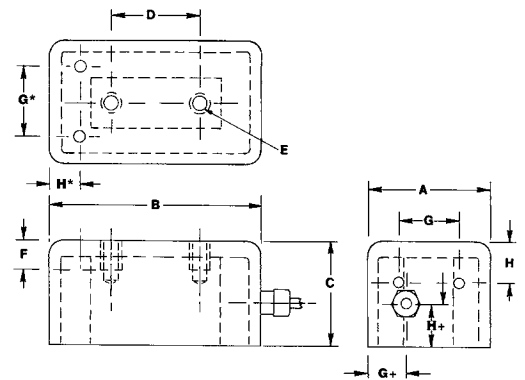

Electromagnets and Power Supplies

Handle Ferrous Materials Safely and Securely with Bunting® Electromagnets

Power Supplies

Electromagnets must be able to release ferrous objects as readily as they attract and hold them. Release is the function of the Power Supply – not the magnet. Power Supplies render a reverse current that ensures positive release of even those alloy steels that retain induced magnetism extremely well. All Bunting Power Supplies are designed to provide D.C. power for industrial electromagnets.

BPS1 Power Supplies feature a 3-position manual control switch for on-off-release, an indicator light, 6' input cord with plug, 3' output cord, and a splash-resistant enclosure.

BPS2 Power Supplies are designed for heavy-duty manual control and feature an oil-tight enclosure, a 3-position toggle type control switch mounted on the enclosure, an isolation transformer with dual-voltage single-phase input, and an accessible terminal connection strip.

BPS3 Power Supplies cycle and release rapidly and cleanly, making them excellent for high-speed automated processes. An SPST switch, limit switch, or PLC output may be used to operate the Power Supply. The release cycle is completely automatic, so operator judgement is not required even with manual switches. An adjustable timed pulse of reverse current to the magnet effectively releases the load. BPSE Power Supplies are ideal for robotics or “pick and place” applications.

BPS4 Power Supplies are designed for heavy-duty, lift-magnet type applications and may also be used as remote controls. They consist of an inexpensive combination drum switch and built-in rectifier.

Note: Total wattage of all magnets powered by a single Bunting Power Supply must not exceed the wattage rating of the Power Supply. For example, one to five 3-watt magnets can be used with a 15-watt Power Supply.

Part No.	Size H x W x D	Watts	Input VAC	Output VDC	Part No.	Size H x W x D	Watts	Input VAC	Output VDC
BPS1-0015-12	8 X 5 X 5	15	120	12	BPS3-0015-12	10 X 8 X 4	15	120/240	12
BPS1-0015VP-12	8 X 5 X 5	15	120	12 Variable	BPS3-0050-12	12 X 10 X 5	50	120/240	12
BPS1-0030-12	8 X 5 X 5	30	120	12	BPS3-0100-12	12 X 10 X 5	100	120/240	12
BPS1-0030VP-12	8 X 5 X 5	30	120	12 Variable	BPS3-0050-110	12 X 10 X 5	50	240/480	110
BPS1-0100-12	8 X 5 X 5	100	120	12	BPS3-0100-110	12 X 10 X 5	100	240/480	110
BPS1-0100VP-12	8 X 5 X 5	100	120	12 Variable	BPS3-0200-110	12 X 10 X 5	200	240/480	110
BPS1-0150-110	8 X 5 X 5	150	120	110	BPS3-0300-110	20 X 16 X 7	300	240/480	110
BPS1-0150VP-110	8 X 5 X 5	150	120	110 Variable	BPS3-0500-110	20 X 16 X 7	500	240/480	110
BPS1-0300-110	8 X 5 X 5	300	120	110	BPS3-0750-110	20 X 16 X 7	750	240/480	110
BPS1-0300VP-110	8 X 5 X 5	300	120	110 Variable	BPS3-1000-110	20 X 16 X 7	1000	240/480	110
BPS2-0050-12	8 X 6 X 4	50	120/240	12	BPS3-2000-110	24 X 20 X 9	2000	240/480	110
BPS2-0100-12	12 X 10 X 5	100	120/240	12	BPS3-3000-110	24 X 24 X 11	3000	240/480	110
BPS2-0050-110	12 X 10 X 5	50	240/480	110	BPS4-0300-110	2-1/4 X 3 X 5	300	120	110
BPS2-0100-110	12 X 10 X 5	100	240/480	110					
BPS2-0200-110	12 X 10 X 5	200	240/480	110					
BPS2-0300-110	20 X 16 X 7	300	240/480	110					
BPS2-0500-110	20 X 16 X 7	500	240/480	110					
BPS2-0750-110	20 X 16 X 7	750	240/480	110					
BPS2-1000-110	20 X 16 X 7	1000	240/480	110					
BPS2-2000-110	24 X 20 X 9	2000	240/480	110					

All dimensions are in inches.



BPS3



BPS1



BPS1 with optional
Variable Voltage Control

Electromagnets and Power Supplies

Handle Ferrous Materials Safely and Securely with Bunting® Electromagnets

Low Profile Electromagnets

The BLP series Electromagnets feature a low profile height of 1/2" for the BLP1 series and 3/4" for the BLP2 series.

Multiple pole design and large pole area create a shallow field depth with excellent pounds-per-square-inch ratings that enhance performance on thin material.

Can be used as a single unit for small work or in multiples on a spreader bar for larger workpieces.

BLP series Electromagnets are able to lift one sheet at a time off a stack when used in conjunction with rectifier-controllers equipped with variable power.

Consult factory for recommendations.

1/2 Inch Low Profile Electromagnets – 12 VDC*

Part No. A	SPECIFICATIONS			POUNDS PULL VS METAL THICKNESS					
	Length	Watts	Net Weight	31 ga .0105	28 ga .0149	20 ga .0359	16 ga .0598	11 ga .1196	7 ga .1793
BLP1-1015-12	1 1/2 dia	3.8	2 oz	0.5 lb	1.5 lb	6 lb	11 lb	24 lb	30 lb
BLP1-3048-12	4 3/4	8.4	5 oz	4.0	5.5	20	40	94	114
BLP1-4060-12	6	11.2	14 oz	4.0	6.0	22	50	120	145
BLP1-6085-12	8 1/2	16.8	1 lb 3 oz	5.5	8.5	27	71	171	209
BLP1-9124-12	12 3/8	25.7	1 lb 10 oz	8.0	13.0	43	105	250	307

All dimensions are in inches.

Cross-section of all units: 1/2" thick x 1-1/2" wide – Units mounted using #10 socket head screws.

* Optional voltages available at additional cost .

Any group of 12 volt electromagnets to be energized by a single rectifier-controller should not exceed 100 watts.

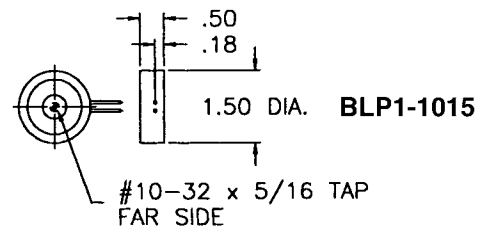
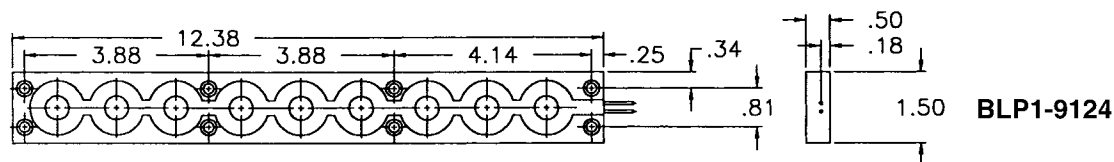
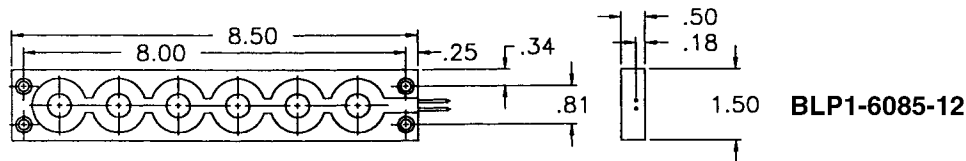
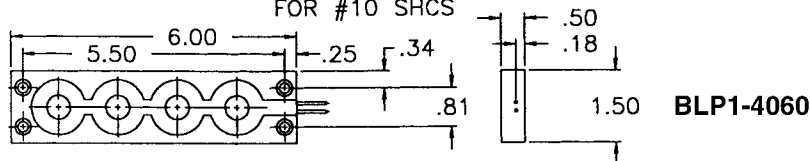
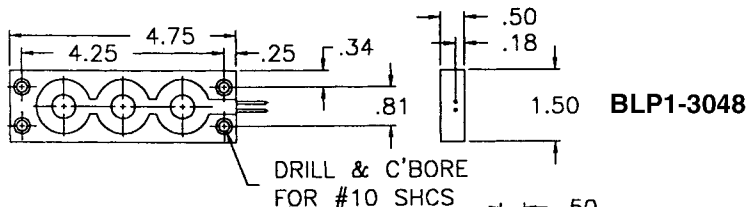
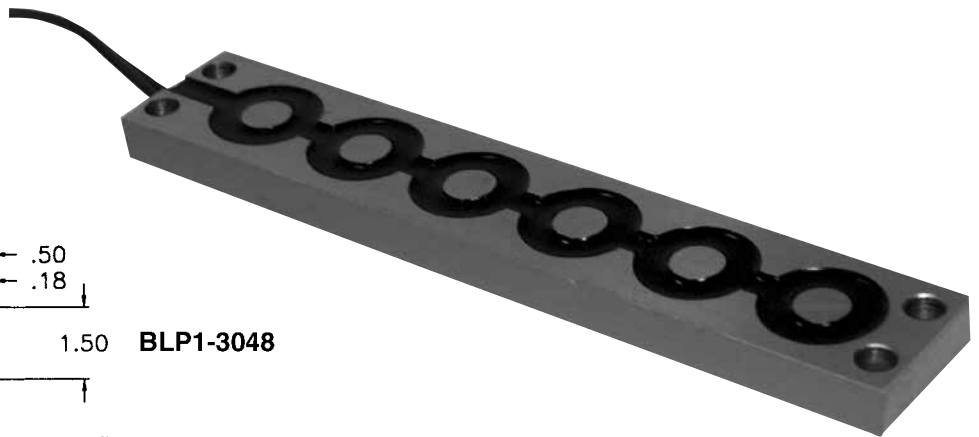

Electromagnets and Power Supplies

Handle Ferrous Materials Safely and Securely with Bunting Electromagnets

3/4 Inch Low Profile Electromagnets – 110 VDC*

Part No.	SPECIFICATIONS			POUNDS PULL VS METAL THICKNESS					
	Length A	Watts	Net Weight	31 ga .0105"	28 ga .0149"	20 ga .0359"	16 ga .0598"	11 ga .1196"	7 ga .1793"
BLP2-1020-110	2 dia	3.9	9 oz	1.0 lb	1.5 lb	6 lb	16 lb	42 lb	66 lb
BLP2-4080-110	8	16.0	3 lb	4.0	7.0	23	64	171	266
BLP2-6120-110	12	4 lb 5 oz	6.0	10.0	35	100	260	400	
BLP2-8160-110	16	31.0	6 lb	8.5	15.0	55	120	320	505

All dimensions are in inches.

Cross-section of all units: 3/4" thick x 2" wide – Units mounted using 1/4" socket head screws.

* Optional voltages available at additional cost.

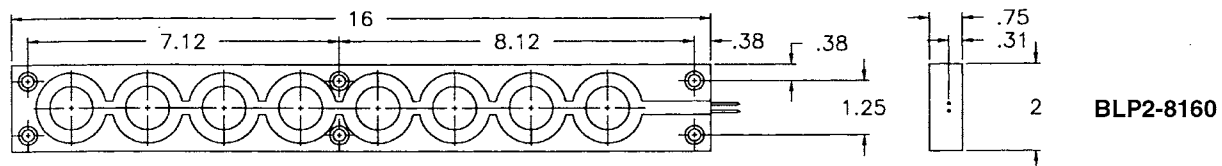
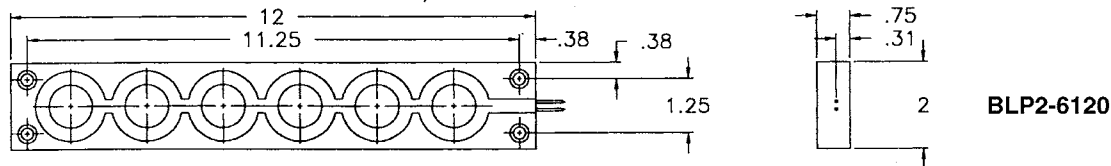
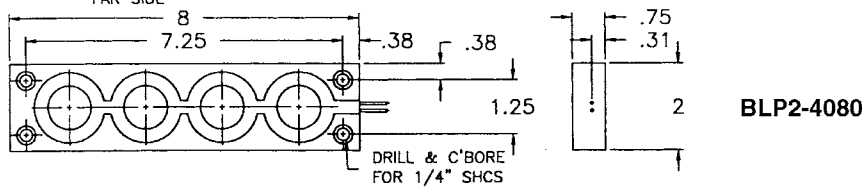
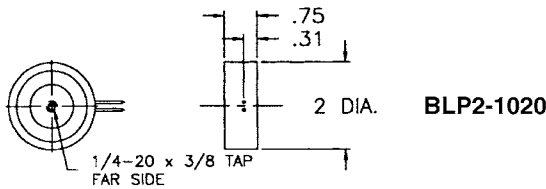
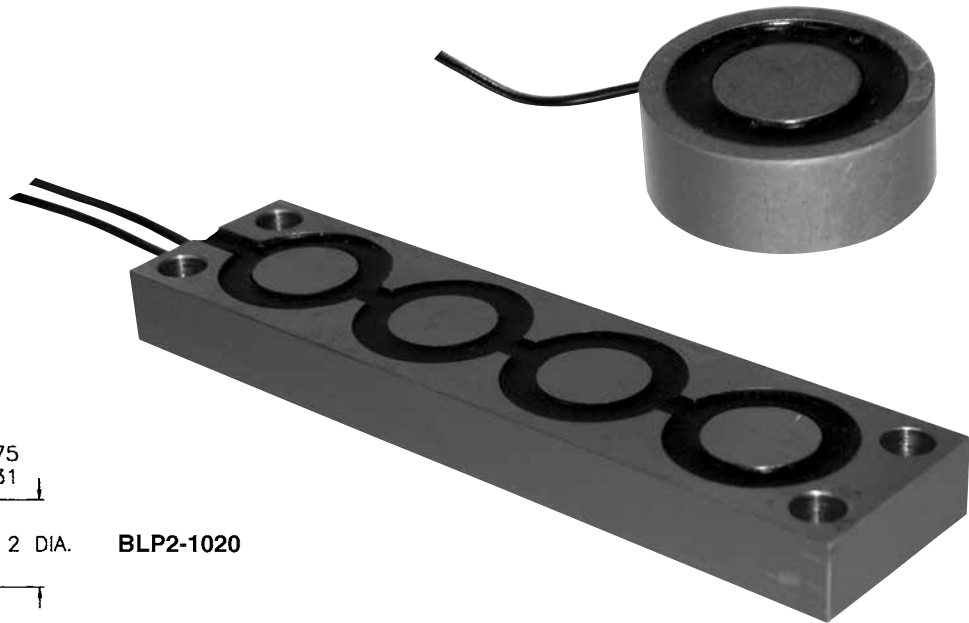

Permanent Magnetic Lifters

Save Time and Labor...Get Added Safety

Bunting® MagLift™ Hand-Controlled Permanent Magnetic Lifters

Bunting® MagLift Permanent Magnetic Lifters are powered by blocks of high-energy neodymium magnetic material. Switching is achieved by making one of these blocks reversible. In the "on" position, the reversible block is in parallel with the static blocks so that a concentrated magnetic field is produced at the pole feet for lifting. In the "off" position, the reversible block is rotated through 180 degrees to provide a total magnetic short circuit within the lifter body.



Standard Magnetic Lifter

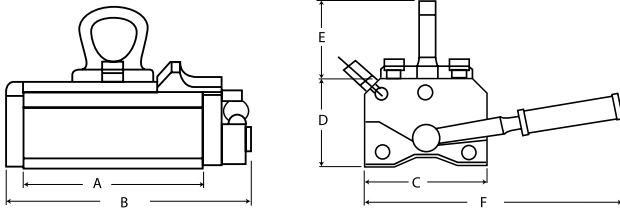

3:1 Safety Factor

Force/Air Gap Curve – Hand Controlled

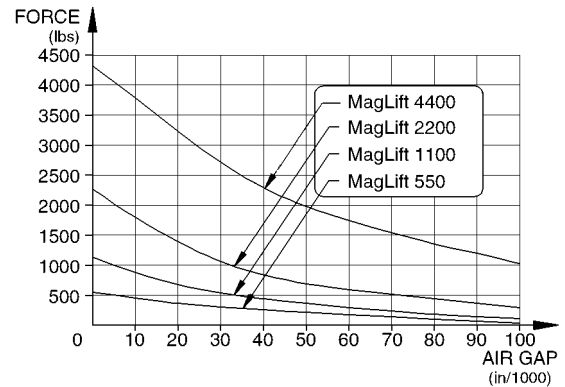

Part No.	Lifter Weight (lbs)	Dimensions						Safe Work Load (lbs)	Flat Section		Round Section		
		A (inches)	B (inches)	C (inches)	D (inches)	E (inches)	F (inches)		Min. Thickness (inches)	Max Length (inches)	Safe Work Load (lbs)	Max Diameter (inches)	Max Length (inches)
MagLift275	9.9	4.3	5.9	3.0	2.4	2.1	5.9	275	0.6	60	110	10	60
MagLift550	18.7	6.5	8.3	3.5	2.8	3.0	7.9	550	0.8	60	220	12	60
MagLift1100	38.5	8.9	11.1	4.2	3.5	4.1	9.6	1100	1.0	80	440	16	80
MagLift2200	80.3	12.8	15.4	5.4	4.1	4.4	14.4	2200	1.4	120	880	18	120
MagLift4400	173.8	15.7	19.0	7.3	5.2	6.7	20.7	4400	2.8	120	1760	24	120

Above values are based on cold rolled mild steel.

**FREE
10-DAY
TRIAL OFFER**

We are so sure that the Bunting Permanent Magnetic Lifters will prove a valuable production aid in your plant that we will ship you a test unit on a 10-day trial basis. If it doesn't work out, return it and pay only the freight for getting it to you and back.

Offer Only Available in the U.S.A.

Magnetic Drive Rollers



Magnetic Drive Rollers

MAGNETIC DRIVE ROLLERS					
PART NO.	"A" DIA.	"B" BORE	"C" WIDTH	"D" KEYWAY	SET "E" SCREW
BM102DR	2 5/8	3/4	1 1/2	3/16	#10-32
BM104DR	4 5/8	1 1/2	1 1/2	3/8	1/4-20
BM204DR	4 5/8	1 1/2	3 1/2	3/8	3/8-16



Options: Chrome plate pole pieces are available upon request. Rare Earth models are also available.

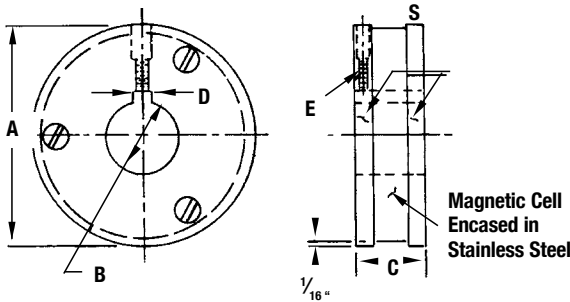

BM102DR & BM104DR

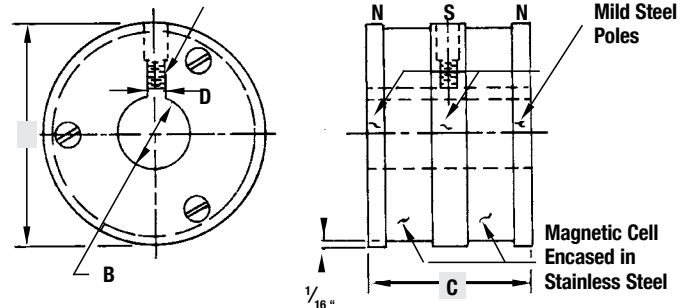

BM204DR

PART NO.	Drive Force (lbs)					Holding Value (lbs)*		
	SHEET GAUGE & THK.					DIRECT CONTACT	.062 AIR GAP	.120 AIR GAP
	#28GA. (.015)	#22GA. (.027)	#16GA. (.055)	#12GA. (.095)	.250			
BM102DR	0.50	1.75	4.63	5.5	5.25	14.5	2.5	1.0
BM104DR	0.88	2.75	10.0	15.0	16.0	23.0	5.5	2.75
BM204DR	1.75	4.88	13.75	23.0	36.81	50.0	15.0	7.75

Note: Optional Chrome Plated Poles will have drive ratings reduced 15% from the values shown above.

300 SERIES Stainless Steel Shaft recommended so as not to short out Magnetic Field.

*Using 1/8" x 1" x 4" Test Plate (C-1018)

Permanent Magnetic Sheet Fanners

Reduce Handling Time...Increase Production with Bunting® Sheet Fanners

Work Faster, Work Safer with Bunting® Sheet Fanners

Put an end to manually prying apart oily, sticky, polished or prefinished ferrous sheets. Bunting® Permanent Magnetic Sheet Fanners are a faster, safer alternative for handling stacks of sheet stock. They provide a constant, powerful magnetic force that automatically fans sheets apart – without the risk of electrical hazards. Machine operators and robotic arms can reliably and safely remove one sheet at a time, eliminating the chance of “doubles” jamming or damaging your machinery.

Separate Stacked Ferrous Sheets with Permanent Magnetic Power

Inside their rugged, stainless steel housings, Bunting® Sheet Fanners use high-energy permanent magnets to separate stacks by inducing like polarities in adjacent sheets, causing magnetic repulsion between them. This repulsion fans the sheets apart. When the top sheet is removed, the next sheet rises to take its place. The distance between the top two sheets will average between 3/4” to 1 1/4”, depending on the magnetic strength of the Fanner and the size of the sheets. Fanners can be ganged to handle especially large or heavy-gauge sheets.

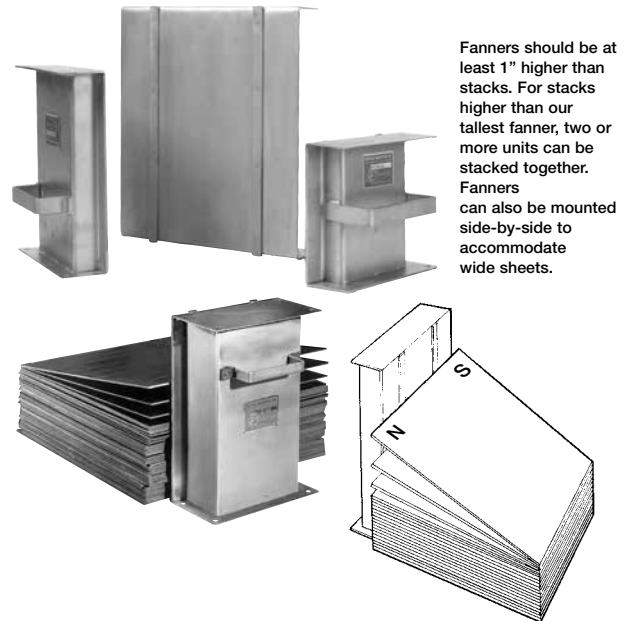

Fanners should be at least 1” higher than stacks. For stacks higher than our tallest fanner, two or more units can be stacked together. Fanners can also be mounted side-by-side to accommodate wide sheets.



* Bunting® Rotary Switchable Fanners carry U.S. Patent No. 6,481,706

Select Standard or Switchable Fanners*

Standard Sheet Fanners are completely self-contained and come with both predrilled mounting holes for permanent installation and carrying handles for moving between workstations. They are available in two standard face widths and can be stacked one above the other or mounted side-by-side to accommodate a wide range of stack and sheet sizes.

Bunting® Switchable Sheet Fanners are available in Generation I and Generation II models, both of which can be “turned off” to avoid accidents while being resupplied with sheets. Both models are patented (U.S. Patent No. 6,481,706) and outfitted with powerful Rare Earth magnets for outstanding separation performance. Both feature reliable pneumatic mechanisms to turn the magnetic field on and off.

Generation I Switchable Sheet Fanners use a pneumatic rotary actuator to control the fanning action by rotating a single-pole Rare Earth magnetic element, which is mounted near the center of the housing. Generation I Switchable Fanners are a compact 4” wide to fit tight spaces and handle lighter loads.

Generation II Switchable Sheet Fanners have a 7” wide face plate and produce a stronger fanning action suited to larger blanks and thicker gauge steel. They use a conventional pneumatic cylinder to rotate a two-pole Rare Earth magnetic element mounted at a pivot point set close to the side of the housing. With this side-pivot geometry, rotating the magnet just 90 degrees faces it toward a built-in shorting circuit to cancel the external field.

**FREE
10-DAY
TRIAL OFFER**

We are so sure that the Bunting® Sheet Fanner will prove a valuable production aid in your plant that we will ship you a test unit on a 10-day trial basis. If it doesn't work out, return it and pay only the freight for getting it to you and back.

Excluding Generation I and II Switchable Sheet Fanners.

Offer Only Available in the U.S.A.

Permanent Magnetic Sheet Fanners

Reduce Handling Time...Increase Production with Bunting Sheet Fanners



Standard Magnetic Sheet Fanners

Ordering Information

Part numbers for sheet fanners are made up of three parts. The first two letters are always the same (SF) and indicate that the part number represents a sheet fanner. The second part consists of digits that indicate the maximum sheet size the sheet fanner is designed to "fan". The third part is the final two digits and represent the height of the unit. (Specials upon request)

Part Number Explanation

SF	11	06
Product	Sheet Size	Height
SF = Sheet Fanner	11 = 19 ga. through 28 ga. under 20" x 20" in size	06 = 6 1/8"
	12 = 14 ga. through 18 ga. under 20" x 20" in size	09 = 9 1/8"
	13 = 10 ga. through 13 ga. under 20" x 20" in size	12 = 12 1/8"
	14 = 19 ga. through 28 ga. over 20" x 20" in size	15 = 15 1/8"
	15 = 14 ga. through 18 ga. over 20" x 20" in size	
	16 = 10 ga. through 13 ga. over 20" x 20" in size	

Small Sheets

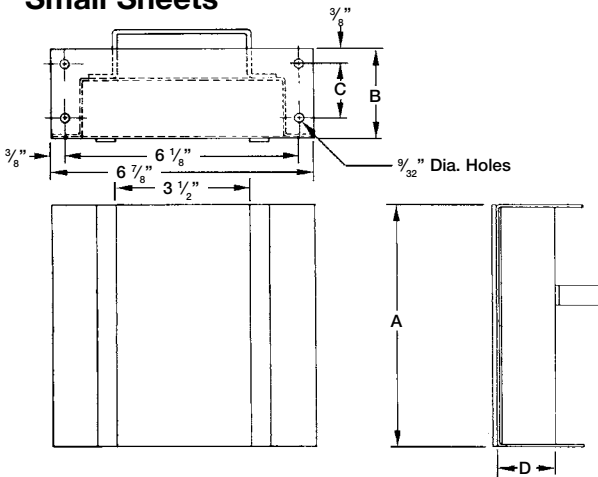

Part No.	A (Height)	B	C	D	Fanner Face Width	Sheet Gauge Capacity
SF1106	6 1/8"	2 1/4"	1 3/8"	1 1/4"	6 1/8"	19 ga. (.0418) through 28 ga. (.0149)
SF1109	9 1/8"	2 1/4"	1 3/8"	1 1/4"	6 1/8"	19 ga. (.0418) through 28 ga. (.0149)
SF1112	12 1/8"	2 1/4"	1 3/8"	1 1/4"	6 1/8"	19 ga. (.0418) through 28 ga. (.0149)
SF1115	15 1/8"	2 1/4"	1 3/8"	1 1/4"	6 1/8"	19 ga. (.0418) through 28 ga. (.0149)
SF1206	6 1/8"	2 1/4"	1 3/8"	1 1/2"	6 1/8"	14 ga. (.0747) through 18 ga. (.0478)
SF1209	9 1/8"	2 1/4"	1 3/8"	1 1/2"	6 1/8"	14 ga. (.0747) through 18 ga. (.0478)
SF1212	12 1/8"	2 1/4"	1 3/8"	1 1/2"	6 1/8"	14 ga. (.0747) through 18 ga. (.0478)
SF1215	15 1/8"	2 1/4"	1 3/8"	1 1/2"	6 1/8"	14 ga. (.0747) through 18 ga. (.0478)
SF1306	6 1/8"	3 1/4"	2 3/8"	2 1/2"	6 1/8"	10 ga. (.1345) through 13 ga. (.0897)
SF1309	9 1/8"	3 1/4"	2 3/8"	2 1/2"	6 1/8"	10 ga. (.1345) through 13 ga. (.0897)
SF1312	12 1/8"	3 1/4"	2 3/8"	2 1/2"	6 1/8"	10 ga. (.1345) through 13 ga. (.0897)
SF1315	15 1/8"	3 1/4"	2 3/8"	2 1/2"	6 1/8"	10 ga. (.1345) through 13 ga. (.0897)

Select these models for sheet sizes up to 20" x 20". Narrow blanks can be even longer. All dimensions are in inches.

Large Sheets

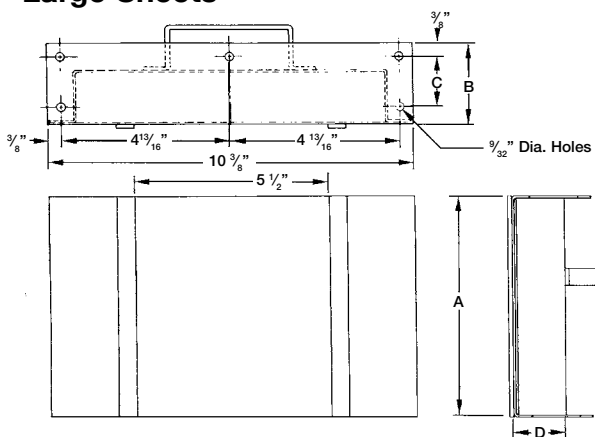

Part No.	A (Height)	B	C	D	Fanner Face Width	Sheet Gauge Capacity
SF1406	6 1/8"	2 1/4"	1 3/8"	1 1/4"	10 3/8"	19 ga. (.0418) through 28 ga. (.0149)
SF1409	9 1/8"	2 1/4"	1 3/8"	1 1/4"	10 3/8"	19 ga. (.0418) through 28 ga. (.0149)
SF1412	12 1/8"	2 1/4"	1 3/8"	1 1/4"	10 3/8"	19 ga. (.0418) through 28 ga. (.0149)
SF1415	15 1/8"	2 1/4"	1 3/8"	1 1/4"	10 3/8"	19 ga. (.0418) through 28 ga. (.0149)
SF1506	6 1/8"	2 1/4"	1 3/8"	1 1/2"	10 3/8"	14 ga. (.0747) through 18 ga. (.0478)
SF1509	9 1/8"	2 1/4"	1 3/8"	1 1/2"	10 3/8"	14 ga. (.0747) through 18 ga. (.0478)
SF1512	12 1/8"	2 1/4"	1 3/8"	1 1/2"	10 3/8"	14 ga. (.0747) through 18 ga. (.0478)
SF1515	15 1/8"	2 1/4"	1 3/8"	1 1/2"	10 3/8"	14 ga. (.0747) through 18 ga. (.0478)
SF1606	6 1/8"	3 1/4"	2 3/8"	2 1/2"	10 3/8"	10 ga. (.1345) through 13 ga. (.0897)
SF1609	9 1/8"	3 1/4"	2 3/8"	2 1/2"	10 3/8"	10 ga. (.1345) through 13 ga. (.0897)
SF1612	12 1/8"	3 1/4"	2 3/8"	2 1/2"	10 3/8"	10 ga. (.1345) through 13 ga. (.0897)
SF1615	15 1/8"	3 1/4"	2 3/8"	2 1/2"	10 3/8"	10 ga. (.1345) through 13 ga. (.0897)

Select these models for sheet sizes larger than 20" x 20". For extra wide and heavy sheets, two units side by side may be required.

If you have any questions about the model required for your work, call to speak with a Bunting sales representative.

All dimensions are in inches.

Permanent Magnetic Sweepers

For Floors, Roadways, and Parking Areas

Bring big cleanup jobs down to size with Bunting® Permanent Magnet Sweepers. We have suspended, towable, and manual models ready to tackle any size job in or around your plant. They're all ruggedly built, easy to operate, and designed for years of trouble-free, labor-saving service.

Magnetic Sweeper Bars Reduce Hazards and Cleanup Costs All Around Your Facility or Work Site

Bunting® Permanent Magnetic Sweeper Bars are easy to mount, easy to use. They clamp under forks for use with forklifts, or they can be suspended by eyebolts beneath pickups and other vehicles. Sweeper Bars are available in 36", 48", and 60" lengths. For best results, Sweeper Bars should be suspended 2 to 4 inches above the floor or ground and vehicle speeds kept as low as practical for effective capture of ferrous parts and debris. To clean, just wipe objects off and away from the magnetic bar.

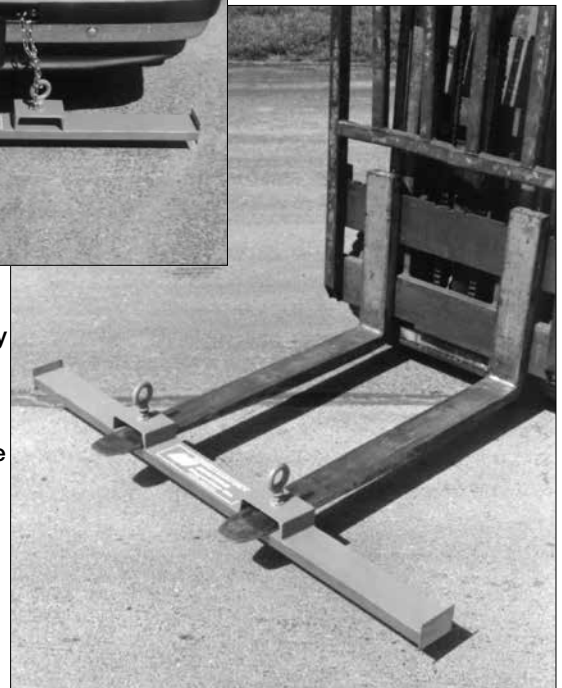

Part No.	Length	Depth
XHDS-36	36"	3 ¹³ / ₁₆ "
XHDS-48	48"	3 ¹³ / ₁₆ "
XHDS-60	60"	3 ¹³ / ₁₆ "

Push/Pull/Tow Sweepers Enhance Safety, Reduce Costly Tire Damage on Your Plant Floor, Roadways, and Parking Areas

Hitch these rugged Bunting® Magnetic Push/Pull/Tow Sweepers to your forklifts, tractors, or maintenance vehicles to clear away ferrous parts and debris. They can also be manually pushed or pulled. The magnet is suspended from the axle shaft so that the handle can be operated at any height without adjustments.

Push/Pull/Tow Sweepers are available in 4 and 6 foot models. Ground clearance for the powerful heavy-duty magnet is adjustable from 1 to 3 inches. Cleaning is easy.

Part No.	Pick Up Width
PPTS-48	48"
PPTS-72	72"

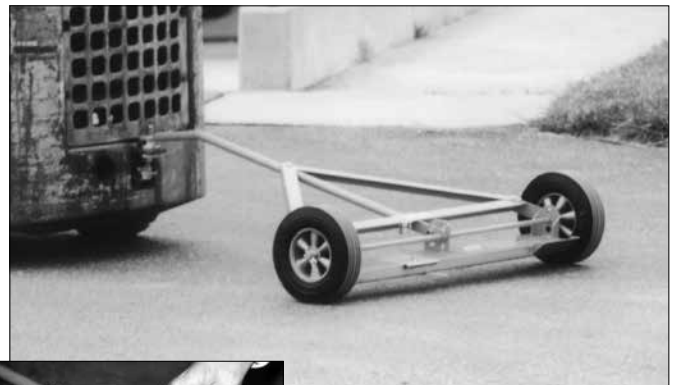

Permanent Magnetic Sweepers

For Floors, Roadways, and Parking Areas



Self-Cleaning Push Sweepers Remove Tramp Iron Quickly and Easily

The Push Sweeper is an economical, labor-saving solution to the problem of keeping plant floors, parking areas, sidewalks, and construction sites free of damaging ferrous debris. The powerful "high reachout" plate magnet rides on 7" diameter plastic wheels with rubber treads for easy going even on rough surfaces. Push Sweepers offer balanced weight for comfortable operation and fold-down handles for space-saving storage. They're available in 2-foot and 3-foot widths.

Part No.	Pick Up Width	Depth	Operator Handle Height
PS-24	24"	6"	37 ⁵ / ₁₆ "
PS-36	36"	6"	37 ⁵ / ₁₆ "

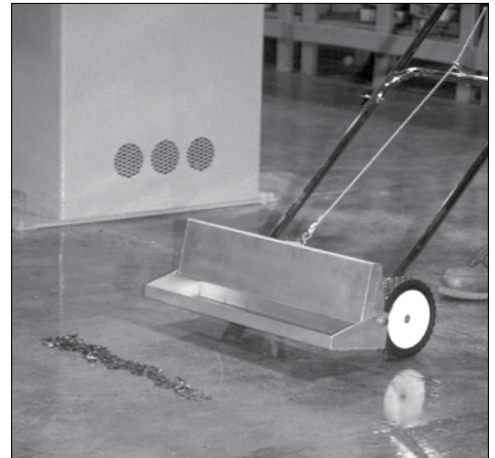

Utility Grade Push Sweeper

Try this low-cost, simple design push sweeper. It attracts all types of ferrous debris and quickly drops collected metal by pulling back on the release handle.

Part No.	Pick Up Width
VPS-114	24"



Tech Tip

These push sweepers can be used to clear miscellaneous bolts, screws and nails from multi-purpose Event Centers and Stadiums. After a temporary stage is dismantled, frequently metal debris is left behind. The PS and VPS models are ideal for this task.

Torpedo In-Line Magnets

Permanent Magnetic Protection for Vacuum Systems

Bunting® Torpedo In-Line Magnets (TIM) provide permanent magnetic protection for vacuum systems in the Plastics Industry. They clamp directly into flexible hoses to capture ferrous contaminants. The compact TIM is an ideal option for use between gaylords and vacuum loaders wherever overhead space is limited and prevents the use of a Bunting® Drawer Magnet.

Torpedo In-Line Magnets feature space-saving design and Neodymium Rare Earth magnets for high-energy tramp-iron capture and holding power.



STANDARD MODELS	
Part No.	Line Size
TIM-15	1 1/2"
TIM-20	2"
TIM-25	2 1/2"

Other sizes available

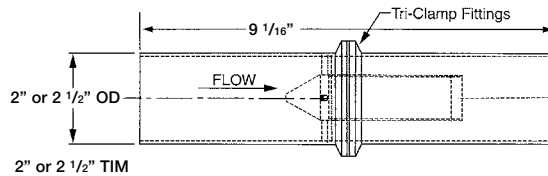
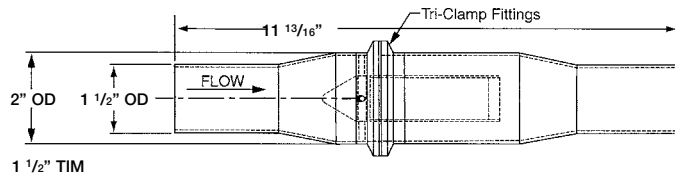

Grinder Plate Magnets

For Plastic Granulators - In Stock, Ready to Ship



Your regrind operation runs an extra risk of tramp metal contamination. Now you can protect it easily and economically with Bunting® Grinder Plate Magnets. They install easily in your granulator's feed tray.

Each Grinder Plate Magnet is manufactured with a rugged cast

aluminum frame. Back plate and magnetic pole face are made of mild steel. Specify grinder feed tray dimensions when ordering. To install, just cut an opening in the feed tray and bolt the pre-drilled flange of the magnet to the tray, using the holes and hardware provided.

(Comes with 1.25", 1/4-20 mounting screws and nuts.)

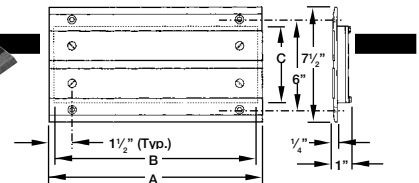
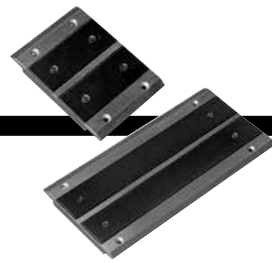

Part No.	A	B	C	Part No.	A	B	C
GPM8006	5 1/2	5	5	GPM8016	15	14 1/2	5
GPM8008	7 1/2	7	5	GPM8018	17	16 1/2	5
GPM8010	9 1/2	9	5	GPM8020	19	18 1/2	5
GPM8012	11 1/2	11	5	GPM8022	21	20 1/2	5
GPM8014	13	12 1/2	5	GPM8024	23	22 1/2	5

All dimensions are in inches.

Bread Pan Magnets

A revolutionary advancement in Bread Pan Magnet Technology.

Our new magnet will significantly increase the life of the magnets on proofing and oven lines. Also, this new, patent pending design will greatly reduce your replacement costs.

Snap On, Snap Off or Traditional

Our advanced design requires no extra pins, fasteners or tools to use. It quickly snaps onto your production line and snaps off when you need to change it. This design eliminates the possibility for contamination due to parts falling into your product. We also have the traditional round screw on bread pan magnet.

Simple to Use, Simple to Maintain

Our unique design features a completely potted and sealed structure. It locks the moisture out. Unlike other competitive products, no moisture can get inside and destroy or degrade the magnet. It eliminates oxidation so there is no erosion or crumbling of the magnet. This design produces a longer life cycle and improves your bottom line due to the lower costs for replacement magnets.

Tailored to Fit

Bunting® Magnetcs has tailored our bread pan magnet for both proofing and oven lines. For proofing lines, our magnet is encased in UHMW and features strong neodymium magnets for maximum holding power. Our oven line style has samarium cobalt magnets within a aluminum design. This is ideal to withstand temperatures up to 475 degrees.

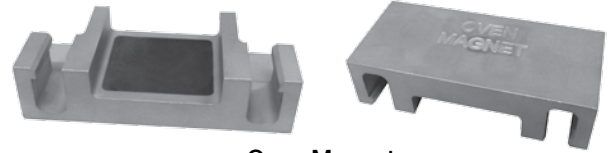

Oven Magnet



Proofer Magnet



Bread and Bun Magnets

Flexible Movement

Another key design feature that other models do not have is the ability to adjust laterally or vertically. Our magnet is built to float on the grid of the oven or proofing line. This allows our magnet to firmly hold the bread pan even if the pan is bowed or has other imperfections. Our magnet reacts to subtle movement as the bread pan travels throughout the baking process, insuring constant contact with the pan.

Part No.	Type	Color	Edge	Material	Used For
BPM-301-PBUN	Proofer	Silver	Notched	Ceramic	Buns
BPM-201-PBRD	Proofer	Silver	Smooth	Ceramic	Bread
BPM-501-OBUN	Oven	Black	Notched	SmCo	Buns
BPM-401-OBRD	Oven	Black	Crimped	SmCo	Bread
BPM-RETAINER*	Retainer	Silver	-	Stainless	All
*Fits all of the above parts plus the BPMV100					
BPMV100	Oven	Silver	-	SmCo	Bread
This is a BPM-401-OBRD plus a smaller retainer (2.250" diameter)					
614692-031314	Proofer	UHMW	-	NEO 35	Bread
Snap on style UHMW and Aluminum: Spevial order based on grid spacing					
LRBPM-1	Proofer	Silver	-	Ceramic	Bread
For use on chain conveyor					

United States Patent No. 8,550,235 B2, Oct. 8, 2013

www.BUYMAGNETS.com / 800-232-4359

 **BUNTING** Magnetcs Co.

Frequently Asked Questions

What does a magnet do?

Magnets do the following things:

- Attract certain materials – such as iron, nickel, cobalt, certain steels and other alloys;
- Exert an attractive or repulsive force on other magnets (opposite poles attract, like poles repel);
- Have an effect on electrical conductors when the magnet and conductor are moving in relation to each other;
- Have an effect on the path taken by electrically charged particles traveling in free space;
- Based on these effects, magnets transform energy from one form to another, without any permanent loss of their own energy. Examples of magnet functions are:
 - A. Mechanical to mechanical – such as attraction and repulsion.
 - B. Mechanical to electrical – such as generators and microphones.
 - C. Electrical to mechanical – such as motors, loudspeakers, charged particle deflection.
 - D. Mechanical to heat – such as eddy current and hysteresis torque devices.
 - E. Special effects – such as magneto-resistance, Hall effect devices, and magnetic resonance.

How permanent is a magnet's strength?

If a magnet is stored away from power lines, other magnets, high temperatures, and other factors that adversely affect the magnet, it will retain its magnetism essentially forever. Modern magnet materials do lose a very small fraction of their magnetism over time. For samarium cobalt materials, for example, this has been shown to be less than 1% over a period of ten years.

What might affect a magnet's strength?

The factors can affect a magnet's strength:

- Heat
- Radiation
- Strong electrical currents in close proximity to the magnet
- Other magnets in close proximity to the magnet

Can a magnet that has lost its magnetism be re-magnetized?

Provided that the material has not been damaged by extreme heat, the magnet can be re-magnetized back to its original strength.

Can I make a magnet that I already have any stronger?

Once a magnet is fully magnetized, it cannot be made any stronger – it is “saturated.” In that sense, magnets are like buckets of water: once they are full, they can't get any “fuller.”

Will a magnet with a 10 lb pull force lift a 10 lb object?

Not necessarily. The pull test is a laboratory test under ideal lab conditions. It is the breakaway force required to separate a given magnet from a flat 1018 steel plate.

When lifting an object with a magnet, many factors can affect the ability of the magnet to lift a given weight. These factors include: surface finish of magnet & object, flatness of magnet & object, coating on either surface & acceleration of lifting motion. Consult our Technical Department for more information on lifting magnets.

It's a question we get often: "How do you measure the strength of a magnet?"

There are actually three common ways to measure the strength of a magnet.

- Gauss meter
- Magnetometer
- Pull-tester

Gauss Meters

Gauss is actually a unit of measurement, so it makes sense that this meter is named accordingly. Gauss meters can be pretty expensive, ranging anywhere from \$400 to \$1500.

First, make sure there aren't any other magnets in the area. You'll need to zero out the display before you start, and having other magnets around will interfere with the reading.

If you see between a +1 and -1 reading, the meter is effectively zeroed out. (It'll bounce around a little bit; you shouldn't expect it to stabilize.)

Once you've zeroed out the reading, hold the probe against the magnet. Slowly move the magnet along the probe to find the highest steady reading. Next, you'll hold the probe against the object from which you're measuring magnetic strength. The reading should stabilize.

You should also measure the other side of the magnet. Average the two readings together for the best accuracy.

Magnetometers

Magnetometers make it easy to compare one magnet to another by measuring in arbitrary units. There are actually two types of magnetometers: one that measures the net magnetism, and one that tracks the vectors of magnetism.

The steps for using a magnetometer are the same as with a gauss meter, except that a magnetometer might have multiple probes. This is so they can measure a wider range of strengths.

Pull-Testers

Perhaps the most common form of measurement, the pull-tester measures the amount of weight a magnet can hold in pounds, kilograms, or any other unit of force.

Pull tests are used when two magnets look alike on the outside, but may be structured differently on the inside, which means they could be magnets of different strengths.

To get the best results, it's easiest to use a pull-test kit. You'll use the materials provided in the kit as your constant – and then compare the magnets which you're trying to measure.

Our test kit includes test pieces and tools which have been selected to offer maximum flexibility for testing a broad range of magnetic separator styles. As with any analytical procedure, consistency and repeatability are key to producing usable test data. You'll find test procedures which when combined with the proper test pieces and tools offer the user a means of achieving accurate test results.

* See page 31 for our Pull Test Kit.

 **BUNTING** Magnetics Co.
Magnet Materials Division

1150 Howard Street • Elk Grove Village, IL 60007 • USA
E-mail: info@BuyMagnets.com • www.BuyMagnets.com

For technical assistance or to order, call

(800) 232-4359

Outside U.S. and Canada 1-847-593-2060

To order products shown in this catalog visit

BuyMagnets.com